



**SigmaGT**  
**MI 3310 / MI 3310 25A**  
**Instruction Manual**  
*Version: 1.0 (HW 3), Code no. 20 752 310*

*Distributor:*

*Manufacturer:*

Metrel d.d.  
Ljubljanska cesta 77  
SI-1354 Horjul  
E-mail: [metrel@metrel.si](mailto:metrel@metrel.si)  
<http://www.metrel.si>

© 2010 – 2014 Metrel



Mark on your equipment certifies that this equipment meets the requirements of the EU (European Union) regulations concerning safety and electromagnetic compatibility

No part of this publication may be reproduced or utilized in any form or by any means without permission in writing from METREL.

<b>1</b>	<b>General description .....</b>	<b>7</b>
1.1	Warnings .....	8
1.2	Warning markings on connector panel .....	8
1.3	Standards applied .....	8
1.4	Battery and charging .....	10
1.5	New battery cells or cells unused for a longer period .....	10
<b>2</b>	<b>Instrument description .....</b>	<b>12</b>
2.1	Front panel .....	12
2.2	Connector panels .....	13
2.3	Safety pre-tests .....	14
2.4	Warnings, messages and symbols .....	15
<b>3</b>	<b>Technical specifications.....</b>	<b>20</b>
3.1	Earth bond resistance.....	20
3.2	Insulation resistance, Insulation – S resistance.....	20
3.3	Subleakage current, Subleakage – S current .....	21
3.4	Differential leakage current.....	21
3.5	Power / Functional test.....	22
3.6	Touch leakage current.....	22
3.7	Polarity test.....	22
3.8	Clamp current.....	22
3.9	PRCD and RCD testing.....	23
3.9.1	<i>Portable RCD trip-out time/current.....</i>	<i>23</i>
3.9.2	<i>General RCD Trip-out time/current.....</i>	<i>23</i>
3.10	Calibration unit – checkbox (optional) .....	24
3.11	General data.....	24
<b>4</b>	<b>Main menu and test modes .....</b>	<b>27</b>
4.1	Help menus .....	27
4.2	Instrument main menu.....	28
4.2.1	<i>Autotest organizer menu .....</i>	<i>28</i>
4.2.2	<i>Autotest custom menu.....</i>	<i>29</i>
4.2.3	<i>Project autotests menu.....</i>	<i>30</i>
4.2.3	<i>Barcode / TAG menu.....</i>	<i>30</i>
4.2.4	<i>Single test menu.....</i>	<i>30</i>
4.2.5	<i>Edit appliance data menu.....</i>	<i>31</i>
4.2.5.1	Users submenu .....	31
4.2.5.1.1	Item editing menu.....	32
4.2.5.2	Device submenu .....	32
4.2.5.3	Test sites submenu .....	33
4.2.5.4	Locations submenu .....	33
4.2.6	<i>Recall / delete / send memory menu.....</i>	<i>34</i>
4.2.7	<i>Upload data / edit lists / check log menu.....</i>	<i>34</i>
4.2.8	<i>Setup menu.....</i>	<i>34</i>
4.2.8.1	Setting date and time .....	35
4.2.8.2	Language selection .....	36
4.2.8.3	Print header.....	36
4.2.8.4	Viewing of instrument data.....	37
4.2.8.5	Display contrast adjustment .....	37
4.2.8.6	Instrument settings.....	38

4.2.8.7	Reset instrument settings.....	39
4.2.8.8	Communication settings.....	40
4.2.8.9	Password .....	42
4.2.8.10	Calibration unit – checkbox (optional) .....	43
<b>5</b>	<b>Single tests .....</b>	<b>46</b>
5.1	Performing measurements in single test mode .....	46
5.2	Measurements – Single tests for appliances .....	47
5.2.1	<i>Earth bond resistance .....</i>	<i>47</i>
5.2.1.1	Compensation of test leads resistance (firmware release 1.24 and up) .....	48
5.2.2	<i>Insulation resistance.....</i>	<i>48</i>
5.2.3	<i>Insulation resistance – S probe .....</i>	<i>51</i>
5.2.4	<i>Substitute leakage current.....</i>	<i>53</i>
5.2.5	<i>Substitute leakage – S probe .....</i>	<i>55</i>
5.2.6	<i>Differential leakage current .....</i>	<i>57</i>
5.2.7	<i>Touch leakage current.....</i>	<i>58</i>
5.2.8	<i>Polarity test .....</i>	<i>60</i>
5.2.9	<i>Clamp current test.....</i>	<i>61</i>
5.2.10	<i>RCD/PRCD test.....</i>	<i>64</i>
5.2.10.1	RCD single test .....	65
5.2.10.2	Automatic RCD test.....	65
5.2.11	<i>Functional test.....</i>	<i>67</i>
5.3	Measurements – Single tests for welding machines.....	69
5.3.1	<i>Continuity of the protective circuit .....</i>	<i>69</i>
5.3.2	<i>Insulation resistance (supply circuit to protective circuit).....</i>	<i>70</i>
5.3.3	<i>Insulation resistance (welding circuit to protective circuit) .....</i>	<i>71</i>
5.3.4	<i>Insulation resistance (supply circuit to welding circuit) .....</i>	<i>72</i>
5.3.5	<i>Insulation resistance (supply circuit of class II equipment to accessible surfaces).....</i>	<i>73</i>
5.3.6	<i>Welding circuit leakage current .....</i>	<i>74</i>
5.3.7	<i>Primary leakage current .....</i>	<i>75</i>
5.3.8	<i>Touch leakage current.....</i>	<i>76</i>
5.3.9	<i>No load voltage .....</i>	<i>76</i>
5.3.10	<i>Clamp current test.....</i>	<i>77</i>
5.3.11	<i>Functional test.....</i>	<i>77</i>
<b>6</b>	<b>Autotest sequences .....</b>	<b>78</b>
6.1	Autotest organizer– general menu .....	78
6.1.1	<i>Autotest organizer operation .....</i>	<i>80</i>
6.1.2	<i>Example of creating a test sequence with autotest organizer .....</i>	<i>81</i>
6.2	Custom autotests .....	82
6.2.1	<i>Viewing, modifying and saving an custom autotest.....</i>	<i>83</i>
6.2.1.1	Modification of an autotest sequence.....	83
6.2.1.2	Saving autotest sequences .....	84
6.2.2	<i>Deleting an existing custom test sequence .....</i>	<i>85</i>
6.3	Project autotests.....	85
6.3.1	<i>Selecting a project autotest.....</i>	<i>86</i>
6.3.2	<i>Starting a project autotest .....</i>	<i>88</i>
6.3.3	<i>Comparison of results (evaluation of result trends) .....</i>	<i>89</i>
6.4	Working with barcode / RFID tag.....	90
6.4.1	<i>Working with RFID tags.....</i>	<i>91</i>

6.4.2	Reading autotest code from barcode / QR code .....	93
6.4.3	Reading barcode for working with results.....	93
6.5	Performing autotest sequences – for appliances.....	94
6.5.1	Visual inspection .....	94
6.5.2	Earth bond resistance measurement.....	95
6.5.3	Insulation resistance measurement.....	95
6.5.4	Insulation resistance – S probe measurement .....	96
6.5.5	Substitute leakage current measurement.....	96
6.5.6	Substitute leakage – S probe measurement .....	97
6.5.7	Differential leakage current .....	98
6.5.8	Touch leakage current measurement.....	98
6.5.9	Polarity test .....	99
6.5.10	TRMS current measurement using clamp current adapter.....	99
6.5.11	RCD/PRCD test.....	100
6.5.12	Functional test.....	100
6.6	Performing autotest sequences – for welding machines .....	102
6.6.1	Visual inspection .....	102
6.6.2	Continuity of the protective circuit .....	102
6.6.3	Insulation resistance (supply circuit to protective circuit).....	103
6.6.4	Insulation resistance (welding circuit to protective circuit).....	104
6.6.5	Insulation resistance (supply circuit to welding circuit).....	104
6.6.6	Insulation resistance (supply circuit of class II equipment to accessible surfaces).....	105
6.6.7	Welding circuit leakage current .....	106
6.6.8	Primary leakage current.....	106
6.6.9	Touch leakage current.....	107
6.6.10	No load voltage .....	108
6.6.11	TRMS current measurement using clamp current adapter.....	108
6.6.12	Functional test.....	108
<b>7</b>	<b>Working with autotest results .....</b>	<b>109</b>
7.1	Saving autotest results .....	109
7.2	Recalling results .....	110
7.3	Deleting results.....	112
7.4	Downloading and printing results .....	113
7.4.1	Send to serial printer .....	114
7.4.1	Send to barcode / QR code printer.....	114
7.5	Data upload / download.....	116
<b>8</b>	<b>Maintenance .....</b>	<b>117</b>
8.1	Periodic calibration .....	117
8.2	Fuses.....	117
8.3	Service .....	117
8.4	Cleaning .....	117
<b>9</b>	<b>Instrument set and accessories.....</b>	<b>118</b>
	<b>Appendix A – Preprogrammed autotests .....</b>	<b>119</b>
	<b>Appendix B – Autotest shortcut codes.....</b>	<b>128</b>
	<b>Appendix C – Country notes.....</b>	<b>130</b>

---

C.1 List of country modifications .....	130
F.2 Modification issues - NL .....	130
F.2.1 Autotest organizer .....	130
F.2.2 Example of creating a test sequence with autotest organizer .....	131
F.2.3 Autotest codes.....	133

# 1 General description

The multifunctional portable test instrument SigmaGT is intended to perform all measurements for testing the electrical safety of portable electrical equipment. The following tests can be performed:

- Earth bond / continuity resistance,
- Insulation resistance,
- Insulation resistance of isolated accessible conductive parts,
- Substitute leakage current,
- Substitute leakage current of isolated accessible conductive parts,
- Differential leakage current,
- Touch leakage current,
- IEC cord polarity test,
- Leakage and TRMS load currents with current clamp,
- Portable RCD test,
- RCD test,
- Functional test.

The instrument has a powerful test data management system. Autotests and single tests can be stored (depending on the application) in approx. 6000 memory locations.

Some instrument's highlights:

- Large graphic LCD display with resolution of 240 × 128 dots, with back-light,
- Over 6000 memory locations in data flash memory for storing test results & parameters,
- Three communication ports (USB and 2 x RS232C) for communication with PC, barcode reader, RFID reader/writer and printers,
- Bluetooth communication with external printer, barcode reader, PC and Android mobile devices (MI 3310 25A only),
- Soft touch keyboard with cursor keys,
- Built in real time clock,
- Built in calibration unit – checkbox (optional),
- Fully compatible with new METREL PATLink PRO PC software package.



Powerful functions for fast and efficient periodic testing are included:

- Pre-programmed test sequences,
- Fast testing with barcode, QR code and/or RFID tag identification systems,
- Test data can be uploaded from PC,
- Comparisons between old and new test results can be performed on site,
- Enables on site printing of test labels.

The operation of the unit is clear and simple – the operator does not need any special training (except reading this instruction manual) to operate the instrument.

## 1.1 Warnings

In order to reach high level of operator safety while carrying out various measurements using SigmaGT instrument, as well as to keep the test equipment undamaged, it is necessary to consider the following general warnings:

- **Read this user manual carefully, otherwise use of the instrument may be dangerous for the operator, for the instrument or for the equipment under test!**
-  **Warning on the instrument means »Read the Instruction manual with special care to safety operation«. The symbol requires an action!**
- **If the test equipment is used in manner not specified in this user manual the protection provided by the equipment may be impaired!**
- **Do not use the instrument and accessories if any damage is noticed!**
- **Consider all generally known precautions in order to avoid risk of electric shock while dealing with hazardous voltages!**
- **Do not use the instrument in supply systems with voltages higher than CAT II 300 V!**
- **Do not connect any external voltage on test terminals! Some test terminals are connected to functional earth during measurements. Possible hazard of electric shock!**
- **Use only standard or optional test accessories supplied by your distributor!**
- **Use only correctly earthed mains outlets to supply the instrument!**
- **In case a fuse has blown follow the instructions in this user manual to replace it!**
- **Instrument servicing and calibration is allowed to be carried out only by a competent authorized person!**
-  **It is advisable not to run tested devices with load currents above 13 A for more than 15 minutes. Load currents higher than 13 A can result in high temperatures of main supply connector and fuse holders!**
- **Instrument contains rechargeable NiCd or NiMh battery cells. The cells should only be replaced with the same type as defined on the battery placement label or in this manual. Do not use standard alkaline battery cells while power supply cable is connected, otherwise they may explode!**
- **If a test code with an earth bond test current not supported by the instrument is selected the SigmaGT instrument will automatically perform the earth bond test with lower test current (200 mA). The operator must be competent to decide if performing the test with lower test current is acceptable!**

## 1.2 Warning markings on connector panel

Refer to chapters **2.1 Front panel** and **2.2 Connector panels**.

## 1.3 Standards applied

The SigmaGT instrument is manufactured and tested according to the following regulations, listed below.



**Electromagnetic compatibility (EMC)**

---

EN 61326-1	Electrical equipment for measurement, control and laboratory use - EMC requirements -- Part 1: General requirements Class B (Portable equipment used in controlled EM environments)
------------	--

---

**Safety (LVD)**

---

EN 61010-1	Safety requirements for electrical equipment for measurement, control, and laboratory use – Part 1: General requirements
EN 61010-2-030	Safety requirements for electrical equipment for measurement, control and laboratory use – Part 2-030: Particular requirements for testing and measuring circuits
EN 61010-031	Safety requirements for electrical equipment for measurement, control and laboratory use - Part 031: Safety requirements for hand-held probe assemblies for electrical measurement and test
EN 61010-2-032	Safety requirements for electrical equipment for measurement, control, and laboratory use - Part 2-032: Particular requirements for hand-held and hand-manipulated current sensors for electrical test and measurement

---

**Functionality**

---

VDE 0404-1	Testing and measuring equipment for checking the electric safety of electric devices - Part 1: General requirements
VDE 0404-2	Testing and measuring equipment for checking the electric safety of electric devices - Part 2: Testing equipment for tests after repair, change or in the case of repeat tests
VDE 0701-0702	Inspection after repair, modification of electrical appliances – Periodic inspection on electrical appliances General requirements for electrical safety
EN 60204-1 Ed.5	Safety of machinery - Electrical equipment of machines - Part 1: General requirements
EN 60439	Low-voltage switchgear and controlgear assemblies
EN 61439-1	Low-voltage switchgear and controlgear assemblies - Part 1: General rules
AS / NZS 3760	In-service safety inspection and testing of electrical equipment
NEN 3140	Operation of electrical installations - Additional Netherlands requirements for low-voltage installations

---

**Note about EN and IEC standards:**

Text of this manual contains references to European standards. All standards of EN 6xxxx (e.g. EN 61010) series are equivalent to IEC standards with the same number (e.g. IEC 61010) and differ only in amended parts required by European harmonization procedure.

**Note:**

- Various devices and appliances can be tested by SigmaGT and in further text the common DUT (abbreviation for Device Under Test) is applied.

## 1.4 Battery and charging

The instrument uses six C size alkaline or rechargeable Ni-Cd or Ni-MH battery cells. Battery condition is always displayed in the lower right display part. In case the battery is too weak the instrument indicates this as shown in below. This indication appears for a few seconds and then the instrument turns itself off.



*Discharged battery indication*

The battery is charged whenever the instrument is connected to mains voltage. The instrument automatically recognizes the connection to the mains voltage and begins charging. Internal circuit controls charging and assures maximum battery lifetime.



Indications of battery charging

- ❑  **When connected to an installation, the instruments battery compartment can contain hazardous voltage inside! Before opening battery compartment cover, disconnect all accessories connected to the instrument and switch off the instrument.**
- ❑ **Ensure that the battery cells are inserted correctly otherwise the instrument will not operate and the batteries could be discharged.**
- ❑ **If the instrument is not to be used for a long period of time, remove all batteries from the battery compartment.**
- ❑ **Alkaline or rechargeable Ni-Cd or Ni-MH batteries (size C) can be used. Metrel recommends only using rechargeable batteries with a capacity of 4000 mAh or higher.**
- ❑ **Do not recharge alkaline battery cells!**

## 1.5 New battery cells or cells unused for a longer period

Unpredictable chemical processes can occur during the charging of new battery cells or cells that have been left unused for a longer period (more than 3 months). Ni-MH and Ni-Cd cells can be subjected to these chemical effects (sometimes called the memory effect). As a result the instrument operation time can be significantly reduced during the initial charging/discharging cycles of the batteries.

In this situation, Metrel recommend the following procedure to improve the battery lifetime:

Procedure	Notes
❑ Completely charge the battery.	At least 10h with in-built charger.
❑ Completely discharge the battery.	This can be performed by using the instrument normally, until the instrument is fully discharged.

❑ Repeat the charge / discharge cycle at least 2-4 times.	Four cycles are recommended in order to restore the batteries to their normal capacity.
---	---

**Notes:**

- ❑ The charger in the instrument is a pack cell charger. This means that the battery cells are connected in series during the charging. The battery cells have to be equivalent (same charge condition, same type and age).
- ❑ One different battery cell can cause an improper charging and incorrect discharging during normal usage of the entire battery pack (it results in heating of the battery pack, significantly decreased operation time, reversed polarity of defective cell...).
- ❑ If no improvement is achieved after several charge / discharge cycles, then each battery cell should be checked (by comparing battery voltages, testing them in a cell charger, etc). It is very likely that only some of the battery cells are deteriorated.

The effects described above should not be confused with the normal decrease of battery capacity over time. Battery also loses some capacity when it is repeatedly charged / discharged. Actual decreasing of capacity, versus number of charging cycles, depends on battery type. This information is provided in the technical specification from battery manufacturer.

## 2 Instrument description

### 2.1 Front panel

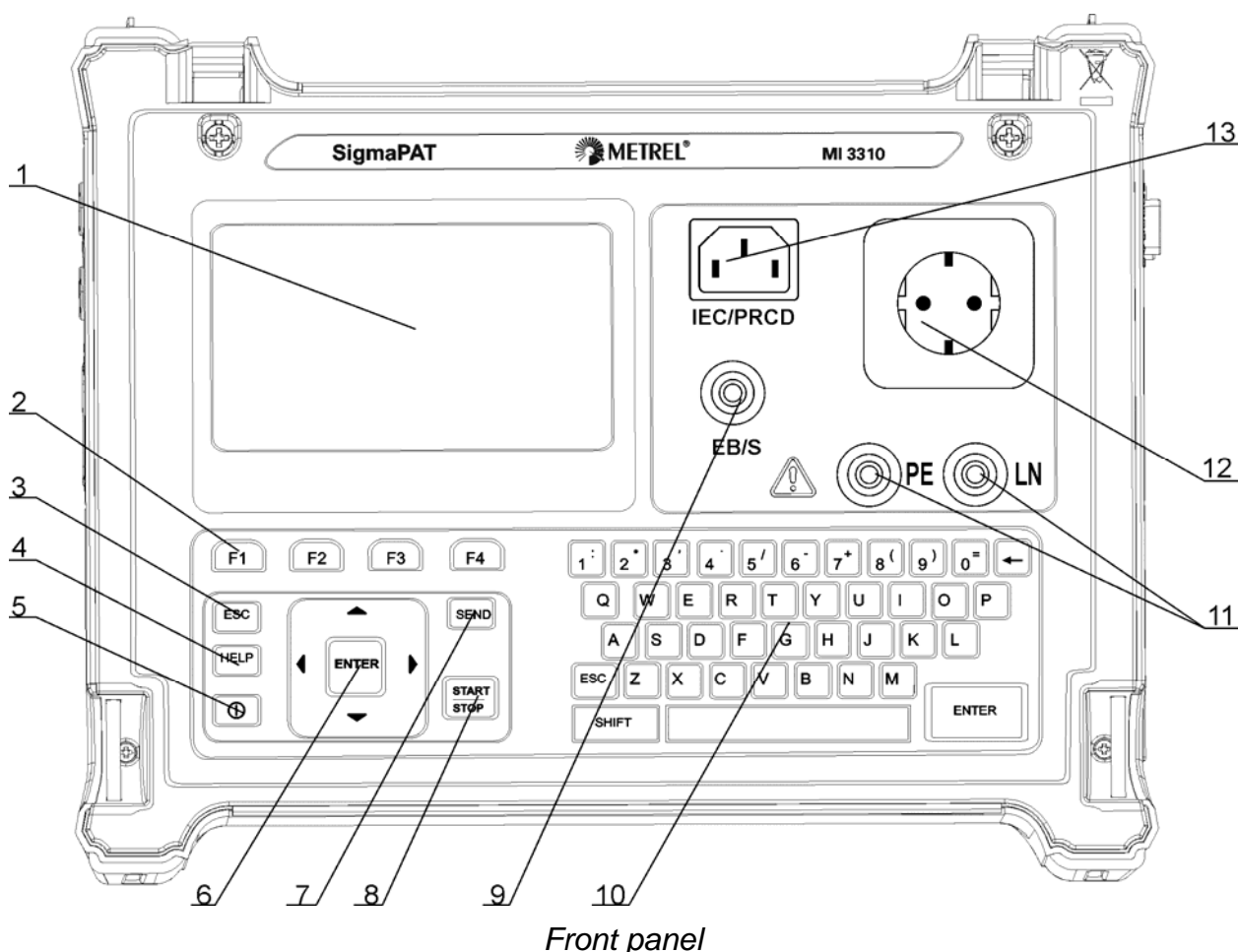

#### Legend:

- |    |   |
|----|---|
| 1  | 240 × 128 dots graphic matrix display with backlight  |
| 2  | Function keys intended for displayed defined options.   |
| 3  | ESCAPE key  |
| 4  | HELP key  |
| 5  | ON / OFF key<br>To switch off the instrument press and hold ON/OFF key for about 2 seconds.   |
| 6  | Cursor keys and ENTER key   |
| 7  | SEND key  |
| 8  | START / STOP key  |
| 9  | Test probe EB/S, used as output for earth bond test and probe input in for class 2 equipment tests (insulation resistance – S, substitute leakage – S, and touch leakage currents). |
| 10 | Alpha-numeric keyboard  |
| 11 | LN and PE sockets for testing the insulation resistance and substitute leakage current of fixed installed DUTs.   |

**Warning!**

- ❑ These sockets are intended only for the connection to de-energized devices.

## 12 Test socket

**Warning!**

- ❑ Dangerous voltage is present on the test socket during the measurement. Maximum output current is 16 A, test only devices with maximum rated supply current no higher than 16 A!

**Note:**

- ❑ For devices incorporated high reactive loading, e.g. motor with rated power > 1.5 kW, it is recommended to start measurement first and to turn on the tested device later.

## 13 IEC appliance connector for testing supply cords

**Warning!**

- ❑ The connector input is for test purpose only; do not connect it to the mains supply!

## 2.2 Connector panels

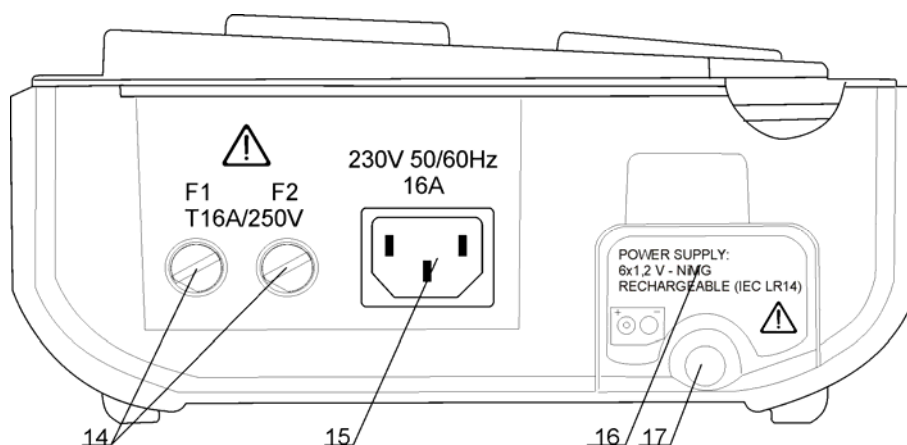

*Left side connector panel*

- 14 Two T16 A / 250 V fuses for instrument protection
- 15 Mains supply connector
- 16 Battery compartment cover
- 17 Fastening screw for battery compartment cover

**Warning!**

- ❑ Disconnect all accessory and tested equipment before opening the battery cover!

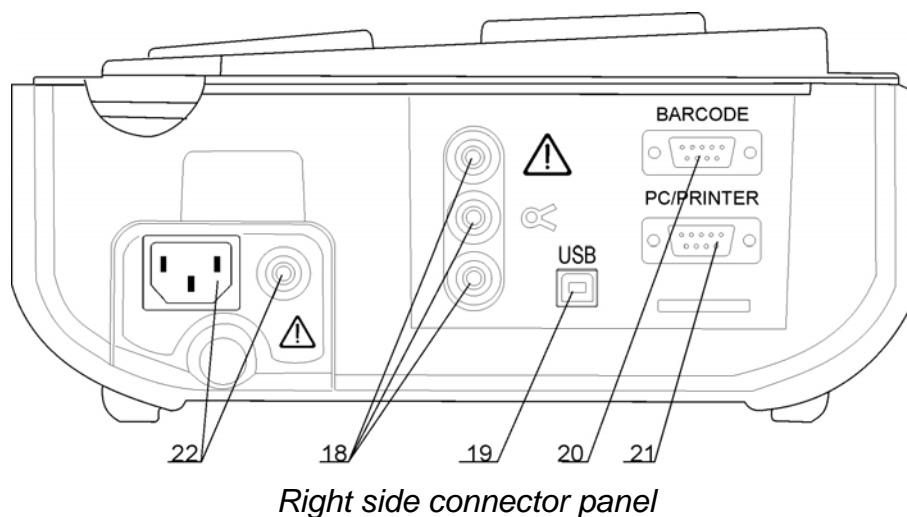

- 18 Current clamp adapter input sockets

**Warnings!**

- Do not connect any voltage source on this input. It is intended only for connection of current clamp with current output. Maximum input current is 30 mA!
- Green socket is connected to the functional earth of the system and is intended for connection with shield of current clamp only.

- 19 USB connector

- 20 Barcode reader connector

- 21 PC / PRINTER connector

- 22 Checkbox input sockets (optional)

**Warning!**

- Do not connect any voltage source on these inputs. They are intended only for connection to the test instrument as described in this manual for the purpose of checkbox test.

## 2.3 Safety pre-tests

Before performing a measurement, the instrument performs a series of pre-tests to ensure safety and to prevent any damage. These safety pre-tests are checking for:

- Any external voltage against earth on mains test socket,
- Excessively high leakage current,
- Excessively high touch leakage current,
- Short circuit or too low resistance between L and N of tested device,
- Correct input mains voltage,
- Input PE connection.

If pre-tests fail, an appropriate warning message will be displayed.

The warnings and measures are described in chapter **2.4 Warnings, messages and symbols**.

## 2.4 Warnings, messages and symbols

### Warnings and messages

<p><b>Mains voltage is not correct or PE not connected. Check mains voltage and PE connection!</b></p>	<p>Warning for improper supply voltage condition. Possible causes:</p> <ul style="list-style-type: none"> <li>- No earth connection or other wiring problem on supply socket.</li> <li>- Incorrect mains voltage.</li> </ul> <p>Determine and eliminate the problem before proceeding! <b>Warning:</b></p> <ul style="list-style-type: none"> <li>- <b>The instrument must be earthed properly!</b></li> </ul>
<p><b>Mains voltage is not correct. Test not allowed!</b></p>	<p>Incorrect mains voltage is applied on the instrument after being battery operated. Measurements are prohibited.</p>
<p><b>No mains voltage. Connect PAT to mains voltage.</b></p>	<p>Instrument not connected to the mains supply voltage. For some measurements like differential / touch leakage tests, PRCD / RCD tests and active polarity, operating the instrument from mains voltage is required. Connect the instrument to the mains voltage and start selected test again.</p>
<p><b>L – N resistance too high (&gt;30 kΩ)! Check fuse and switch. Are you sure to proceed (Y/N)?</b></p>	<p>An excessively high resistance was measured in the fuse pre-test. Indication means that tested device has too low consumption or is:</p> <ul style="list-style-type: none"> <li>- Not connected,</li> <li>- Switched off,</li> <li>- Contains a fuse that has blown.</li> </ul> <p>Select <b>YES</b> or <b>NO</b> with Y or N key.</p>
<p><b>Resistance L – N low! Are you sure to proceed (Y/N)?</b></p>	<p>A low resistance of the device under test (DUT) supply input was measured in the pre-test. This means that it is very likely that an excessively high current will flow after applying power to the DUT. If the high current is only of short duration (caused by a short inrush current) the test can be performed, otherwise not. Select <b>YES</b> or <b>NO</b> with Y or N key.</p>

<p><b>Resistance L – N too low!</b> <b>Are you sure to proceed (Y/N)?</b></p>	<p>An extremely low resistance of the DUT supply input was measured in the pre-test. It is likely that fuses will blow after applying power to the DUT. If the too high current is only of short duration (caused by a short inrush current) the test can be performed otherwise it must be stopped. Select <b>YES</b> or <b>NO</b> with Y or N key. It is recommended to additionally check the DUT before proceeding with the test!</p>
<p><b>Leakage LN-PE high!</b> <b>Are you sure to proceed (Y/N)?</b></p>	<p>Dangerous leakage current (higher than 3.5 mA) will flow if power would be connected to DUT. Select <b>YES</b> or <b>NO</b> with Y or N key. Proceed with testing only if all safety measures have been taken. It is recommended to perform a thorough earth bond test on the PE of the DUT before proceeding with the test.</p>
<p><b>Leakage LN-PE too high!</b> <b>Are you sure to proceed (Y/N)?</b></p>	<p>Dangerous leakage current (higher than 20 mA) will flow if power would be connected to the DUT. Determine and eliminate the problem before proceeding!</p>
<p><b>Leakage LN-PE or EB/S too high!</b> <b>Are you sure to proceed (Y/N)?</b></p>	<p>Dangerous leakage current (higher than 20 mA) would flow if power were connected to the DUT. Select <b>YES</b> or <b>NO</b> with Y or N key. Proceed with testing only if all safety measures have been taken. It is recommended to perform a thorough earth bond test on the PE of the DUT before proceeding with the test.</p>
<p><b>External voltage on test socket too high!</b></p>	<p><b>DANGER!</b> - <b>Voltage on mains test socket or LN/PE terminals is higher than approximately 25 V (AC or DC)!</b> Disconnect the DUT from the instrument immediately and determine why external voltage was detected!</p>
<p><b>External voltage on EB/S too high!</b></p>	<p><b>DANGER!</b> - <b>Voltage on test probe (EB/S) is higher than approximately 25 V (AC or DC)!</b> Disconnect the test probe from the DUT and determine why external voltage was detected!</p>
<p><b>Next test was skipped for safety! Check the device.</b></p>	<p>Instrument skipped the required test because of a failed previous test.</p>



**Overheated!**

Temperature of internal components of the instrument reached their top limit. Measurement is prohibited until the internal temperature has reduced.

---

**Warning!  
More than 80 % of  
memory is occupied.  
Stored data should be  
downloaded to PC.**

Instrument memory is almost full. Download stored results to PC.

---

**Warning!  
Calibration has been  
expired.**

Recalibration of the instrument is required. Contact your dealer.

---

**Measurement aborted,  
contact voltage too  
high (> 50V).**

A too high contact voltage was detected before an RCD test being carried out. Check PE connections!









---

**Hardware error.  
Return the instrument  
to the repair center.**



The instrument detects a serious failure.

---





## Warning symbols

	Remove the EB/S connection, especially if it is connected to any part that will begin to rotate or move when power is applied.
	Connect the test lead to the EB/S test socket.
  	<b>Warning!</b> A high voltage is / will be present on the instrument output! (Insulation test voltage, or mains voltage).
	The DUT should be switched on (to ensure that the complete circuit is tested).
	Connect the lead to be tested to the IEC test terminal.
	Connect current clamp adapter in this test.



## PASS /FAIL indication

	Test passed.
	Test failed.
	Some tests in the autotest sequence were skipped, but all performed tests passed.

### Battery and mains supply indication

	Battery capacity indication.
	Low battery! Battery is too weak to guarantee correct result. Replace or recharge battery cells.
	Instrument connected to the mains supply voltage. When instrument is in idle mode recharging process is in progress.
	Recharging in progress (if instrument is connected to the mains supply voltage).

### Bluetooth indication (optional)

	Bluetooth communication is enabled. Remote device (printer, barcode reader, PC or Android mobile device) can now be connected with the instrument.
	Remote Bluetooth device (printer, barcode reader, PC or Android mobile device) is connected with the instrument.
	Searching for Bluetooth devices or connecting procedure with the selected Bluetooth device (printer, barcode reader, PC or Android mobile device).

### Alpha-numeric entry indication

When using alpha-numeric keyboard, entry type can be selected by using SHIFT key.

<b>1A</b>	Alpha-numeric caps entry (excluding special alphabet characters)
<b>1Ä</b>	Alpha-numeric caps entry (including special alphabet characters)
<b>:ä</b>	Special characters and small caps alphabetic entry (including special alphabet characters)

### 3 Technical specifications

#### 3.1 Earth bond resistance

##### Test current set to 25 A (MI 3310 25A only)

Range	Resolution	Accuracy
0.00 $\Omega$ ÷ 1.99 $\Omega$	0.01 $\Omega$	$\pm(5\%$ of reading + 3 digits)
2.00 $\Omega$ ÷ 19.99 $\Omega$	0.01 $\Omega$	$\pm 10\%$

##### Test current set to 10 A (MI 3310 25A only)

Range	Resolution	Accuracy
0.00 $\Omega$ ÷ 1.99 $\Omega$	0.01 $\Omega$	$\pm(5\%$ of reading + 3 digits)
2.00 $\Omega$ ÷ 19.99 $\Omega$	0.01 $\Omega$	$\pm 10\%$

##### Test current set to 200 mA

Range	Resolution	Accuracy
0.00 $\Omega$ ÷ 1.99 $\Omega$	0.01 $\Omega$	$\pm(5\%$ of reading + 3 digits)
2.00 $\Omega$ ÷ 9.99 $\Omega$	0.01 $\Omega$	$\pm 10\%$
10.0 $\Omega$ ÷ 19.9 $\Omega$	0.1 $\Omega$	$\pm 10\%$

Powered by:.....battery or mains for 200 mA test  
 mains for 10 A and 25 A test

Test currents:.....> 25 A into short circuit at mains voltage of 230 V  
 10 A ( $\pm 5\%$ ) into 100 m $\Omega$  at mains voltage of 230 V  
 200 mA into 2.00  $\Omega$

Open circuit voltage:.....<9 V AC

Test lead compensation...up to 5  $\Omega$

Lead calibration: .....no

Pass levels [ $\Omega$ ]:.....0.10 ÷ 0.90, 1.00 ÷ 9.00

Test duration [s]:.....2, 3, 5, 10, 30

Test method:.....2-wire measurement, floating to earth

Test terminals: .....EB/S test probe – test socket (PE terminal)

EB/S test probe – PE test probe (test current 200 mA only)

#### 3.2 Insulation resistance, Insulation – S resistance

##### Insulation resistance

Range	Resolution	Accuracy
0.000 M $\Omega$ ÷ 0.500 M $\Omega$	0.001 M $\Omega$	$\pm(10\%$ of reading + 5 digits)
0.501 M $\Omega$ ÷ 1.999 M $\Omega$	0.001 M $\Omega$	$\pm(5\%$ of reading + 3 digits)
2.00 M $\Omega$ ÷ 19.99 M $\Omega$	0.01 M $\Omega$	
20.0 M $\Omega$ ÷ 199.9 M $\Omega$	0.1 M $\Omega$	

##### Insulation – S resistance

Range	Resolution	Accuracy
0.000 MΩ ÷ 0.500 MΩ	0.001 MΩ	±(10 % of reading + 5 digits)
0.501 MΩ ÷ 1.999 MΩ	0.001 MΩ	±(5 % of reading + 3 digits)
2.00 MΩ ÷ 19.99 MΩ	0.01 MΩ	

Power by:.....battery or mains  
 Nominal voltages:.....250 V DC, 500 V DC (- 0 %, + 10 %)  
 Measuring current:.....min. 1 mA at 250 kΩ (250 V), 500 kΩ (500 V)  
 Short circuit current:.....max. 2.0 mA  
 Pass levels [MΩ]:.....0.01, 0.10, 0.25, 0.30, 0.50, 1.00, 2.00, 4.0, 7.0, 10.0, none  
 Test duration [s]:.....2, 3, 5, 10, 30, 60, 120, 180 s, none  
 Test terminals:.....Insulation:       Test socket (L+N) – test socket (PE)  
   LN test probe – PE test probe  
   LN test probe – EB/S test probe  
                                   Insulation – S: Test socket (L+N) – EB/S test probe  
   LN test probe – EB/S test probe

### 3.3 Subleakage current, Subleakage – S current

Range	Resolution	Accuracy
0.00 mA ÷ 19.99 mA	0.01 mA	±(5 % of reading + 5 digits)

Powered by:.....battery or mains  
 Open circuit voltage:.....< 50 V AC  
 Short circuit current:.....< 40 mA  
 Measuring resistor:.....2 kΩ  
 Pass levels [mA]:.....0.25, 0.50, 0.75, 1.00, 1.50, 2.25, 2.50, 3.50, 4.0, 4.50, 5.00,  
   5.50, 6.00, 7.00, 8.00, 9.00, none  
 Test duration [s]:.....2, 3, 5, 10, 30, 60, 120, 180, none  
 Displayed current:.....calculated to DUT nominal mains supply voltage  
   230 V x 1.06.  
 Test terminals:.....Sub leakage:       Test socket (L+N) – test socket (PE)  
   LN test probe – PE test probe  
   LN test probe – EB/S test probe  
                                   Sub leakage – S: Test socket (L+N) – EB/S test probe  
   LN test probe – EB/S test probe

### 3.4 Differential leakage current

Range	Resolution	Accuracy
0.00 mA ÷ 9.99 mA	0.01 mA	±(5 % of reading + 5 digits)

Powered by:.....mains  
 Pass levels [mA]:.....0.25, 0.50, 0.75, 1.00, 1.50, 2.25, 2.50, 3.50, 4.00, 4.50, 5.00,  
   5.50, 6.00, 7.00, 8.00, 9.00, none  
 Test duration [s]:.....2 s, 3 s, 5 s, 10 s, 30 s, 60 s, 120 s, 180 s, none  
 Frequency response:.....complies to EN61010-Figure A1  
 Test terminals:.....mains test socket

### 3.5 Power / Functional test

#### Apparent power

Range	Resolution	Accuracy
0.00 kVA ÷ 4.00 kVA	0.01 kVA	±(5 % of reading + 3 digits)

Powered by:.....mains

Test duration [s]:.....2 s, 3 s, 5 s, 10 s, 30 s, 60 s, 120 s, 180 s, none

Test terminals: .....mains test socket

### 3.6 Touch leakage current

Range	Resolution	Accuracy
0.00 mA ÷ 3.99 mA	0.01 mA	±(10 % of reading + 5 digits)

Powered by:.....mains

Pass levels [mA]: .....0.25, 0.50, 0.75, 1.00, 1.50, 2.00, 3.50, none

Test duration [s]:.....2, 3, 5, 10, 30, 60, 120, 180, none

Frequency response: .....complies to EN61010-Figure A1

Test terminals: .....mains test socket or external source – EB/S test probe

### 3.7 Polarity test

#### Standard test

Powered by:.....mains, battery

Test voltage .....<50 V AC

Detects: .....Pass, L-open, N-open, PE-open, L-N crossed, L-PE crossed, N-PE crossed, L-N shorted, L-PE shorted, N-PE shorted, multiple faults

Test terminals: .....Mains test socket – IEC/PRCD test socket

#### Active test

Powered by:.....mains

Test voltage .....Mains voltage, over-current protection > 150 mA

Detects: .....Pass, L-open, N-open, PE-fault, L-N crossed, connection fault

Test terminals: .....Mains test socket – IEC/PRCD test socket

### 3.8 Clamp current

True RMS current using 1000:1 current clamp

Range	Resolution	Accuracy*
0.00 mA ÷ 9.99 mA	0.01 mA	±(5 % of reading + 10 digits)
10.0 mA ÷ 99.9 mA	0.1 mA	±(5 % of reading + 5 digits)
100 mA ÷ 999 mA	1 mA	±(5 % of reading + 5 digits)
1.00 A ÷ 9.99 A	0.01 A	±(5 % of reading + 5 digits)
10.0 A ÷ 24.9 A	0.1 A	±(5 % of reading + 5 digits)

\*It does not consider accuracy of current transformer.

Pass levels [mA]: .....0.25, 0.50, 0.75, 1.00, 1.50, 2.25, 2.50, 3.00, 3.50, 5.00, 9.00,  
 none  
 Test duration [s]: .....2, 3, 5, 10, 30, 60, 120, 180, none  
 Powered by: .....battery or mains  
 Test terminals: .....Clamp inputs

Temperature coefficient outside reference temperature limits is 1 % of measured value per °C.

### 3.9 PRCD and RCD testing

#### 3.9.1 Portable RCD trip-out time/current

AC and A type PRCD trip-out time:

Range	Resolution	Accuracy
0 ms ÷ 300 ms ( $\frac{1}{2} \times I_{\Delta N}$ )	1 ms	±3 ms
0 ms ÷ 300 ms ( $I_{\Delta N}$ )	1 ms	
0 ms ÷ 40 ms ( $5 \times I_{\Delta N}$ )	1 ms	

B type PRCD trip out-current (supported by hardware release 2.0 and up):

Range $I_{\Delta}$	Resolution	Accuracy
$0.2 \times I_{\Delta N} \div 2.2 \times I_{\Delta N}$ (B type)	$0.05 \times I_{\Delta N}$	$\pm 0.1 \times I_{\Delta N}$

Powered by: .....mains  
 Test current type: .....AC (sine-wave), A (pulsed), B (smooth DC)  
 Test currents ( $I_{\Delta N}$ ): .....10 mA, 15 mA, 30 mA  
 Test current multipliers: ... $\frac{1}{2} \times I_{\Delta N}$ ,  $I_{\Delta N}$ ,  $5 \times I_{\Delta N}$   
 Start angle: .....0° (+), 180° (-), both (+,-)  
 Test modes: .....single, autotest  
 Test terminals: .....Mains test socket – IEC/PRCD test socket  
 PASS / FAIL limits: ..... $\frac{1}{2} \times I_{\Delta N}$ :  $t_{\Delta} > 300$  ms  
 $I_{\Delta N}$ :  $t_{\Delta} < 300$  ms  
 $5 \times I_{\Delta N}$ :  $t_{\Delta} < 40$  ms

#### 3.9.2 General RCD Trip-out time/current

Complete measurement range corresponds to EN 61557-6 requirements.  
 Maximum measuring times set according to selected reference for RCD testing.

AC and A type RCD trip-out time:

Range	Resolution	Accuracy
0 ms ÷ 300 ms ( $\frac{1}{2} \times I_{\Delta N}$ )	1 ms	±3 ms
0 ms ÷ 300 ms ( $I_{\Delta N}$ )	1 ms	
0 ms ÷ 40 ms ( $5 \times I_{\Delta N}$ )	1 ms	

**B type RCD trip out-current (supported by hardware release 2.0 and up):**

Range $I_{\Delta}$	Resolution	Accuracy
$0.2 \times I_{\Delta N} \div 2.2 \times I_{\Delta N}$ (B type)	$0.05 \times I_{\Delta N}$	$\pm 0.1 \times I_{\Delta N}$

Powered by:..... mains via tested RCD

Test current type:.....AC (sine-wave), A (pulsed), B (smooth DC)

Test current: ..... $\frac{1}{2} \times I_{\Delta N}$ ,  $I_{\Delta N}$ ,  $5 \times I_{\Delta N}$

Start angle: ..... $0^{\circ}$  (+),  $180^{\circ}$  (-), both (+,-)

Test modes:.....single, autotest

Specified accuracy is valid for complete operating range.

**3.10 Calibration unit – checkbox (optional)****Instrument**

Function	Reference	Accuracy
Earth bond resistance	0.39 $\Omega$	$\pm 1 \%$
	4.70 $\Omega$	$\pm 5 \%$
Insulation resistance	1.200 M $\Omega$	$\pm 1 \%$
	10.00 M $\Omega$	$\pm 1 \%$
Insulation resistance S – probe	1.200 M $\Omega$	$\pm 1 \%$
	10.00 M $\Omega$	$\pm 1 \%$
Substitute leakage current	0.45 mA	$\pm 1 \%$
	3.38 mA	
Substitute leakage current S – probe	0.45 mA	$\pm 1 \%$
	3.38 mA	
Differential leakage current	0.45 mA	$\pm 1 \%$
	3.38 mA	
Touch leakage current	0.45 mA	$\pm 1 \%$
	0.90 mA	

**IEC test cord**

Function	Reference	Accuracy
Polarity	PASS	-

**3.11 General data****Power supply**

Power supply voltage..... 9 V DC (6 $\times$ 1.5 V battery or accu., size C)

Rated supply voltage: ..... 230 V AC

Supply voltage tolerance: .....  $\pm 10 \%$

Frequency of supply voltage: .... 50 Hz, 60 Hz

Max. power consumption: ..... 300 VA (without DUT)

Rated DUT:..... 16 A resistive, 1.5 kW motor



**Overvoltage category**

Instrument:..... Cat II / 300 V

Test socket: ..... Cat II / 300 V

Plug test cable: ..... 300 V CAT II

**Protection classification**

Power supply: ..... Class I, mains supply

Class II, only battery supply

Pollution degree:..... 2

Degree of protection: ..... IP 30 (closed and locked cover)

IP 20 main test socket

Case: ..... shock proof plastic / portable

Display:..... 240\*128 dots graphic matrix display with backlight

Memory:..... 6000 memory locations

**Communication interface**

RS232 interfaces:..... 9600 bps ÷ 115200 bps, 1 start bit, 8 data bits, 1 stop bit

RS232 connectors: ..... 9-pin sub miniature type D, female

USB interface: ..... 9600 bps ÷ 115200 bps

USB connector:..... type B

Bluetooth communication: ..... 115200 bps

Insulation:

Communication ports to PE: ..... 600 k $\Omega$ , 5 %

Dimensions (w×h×d):..... 31cm × 13cm × 25cm

Weight

(with standard accessories): ..... 5 kg

**Reference conditions**

Reference temperature range:.. 15 °C ÷ 35 °C

Reference humidity range:..... 35 % ÷ 65 % RH

**Operation conditions**

Working temperature range: ..... 0 °C ÷ +40 °C

Maximum relative humidity: ..... 85 % RH (0 °C ÷ 40 °C), non-condensing

**Storage conditions**

Temperature range:..... -10 °C ÷ +60 °C

Maximum relative humidity: ..... 90 % RH (-10 °C ÷ +40 °C)

80 % RH (40 °C ÷ 60 °C)

Accuracies apply for 1 year in reference conditions. Temperature coefficient outside these limits is 0.2 % of measured value per °C plus 1 digit, otherwise noted.

Fuses

Test socket protection:..... 2 x T16 A / H 500 V, 6.3 × 32 mm

## 4 Main menu and test modes

The SigmaGT instrument has a user-friendly manipulation. By pressing only a few keys most of the actions can be done. The menu tree of the instrument has been designed to be simple to understand and easy to operate.

The instrument can test appliances in different modes:

- Single test mode,
- Several autotest modes.

After the instrument is switched on, the last menu used will be displayed.

### Note:

- For testing 3-phases appliances and/or welding machines the 3-phase operation mode must be enabled and the SigmaGT must be connected to a Metrel A1322 or A1422 3-phase Active GT / Machine adapter (Plus). Refer to 3-phase adapter for detailed information.

### 4.1 Help menus

The measurement help menus are available in single and autotest modes. They can be accessed with the key HELP before the START key is pressed to initiate the measurement.

Help menus contain schematic diagrams for illustration of proper connection of DUT to the PAT testing instrument.

Keys in help menu:

<b>PgUp (F1) / PgDown (F2)</b>	Selects next / previous help screen.
<b>ESC</b>	Returns to the last test / measurement menu.

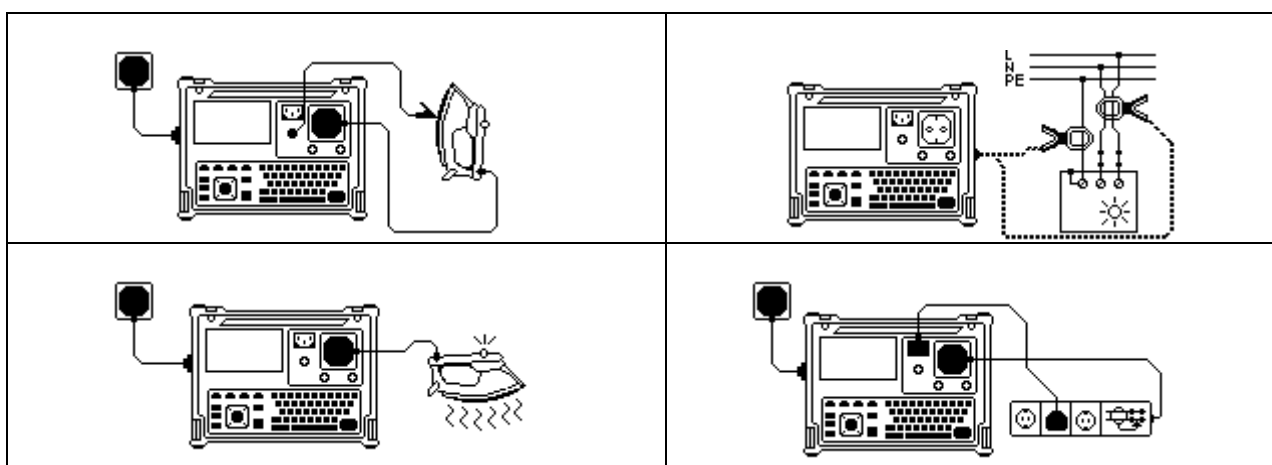

*Example of help screens*

## 4.2 Instrument main menu

From the **Main** menu all the instrument functions can be selected.



*Instrument main menu*

Keys in instrument main menu:

▲ / ▼	Select one of the following menu items: < <b>AUTOTEST ORGANIZER</b> >, pre-defined autosequences, covering requirements of standard; < <b>AUTOTEST CUSTOM</b> >, custom prepared autosequences; < <b>PROJECT AUTOTESTS</b> >, project autosequences; < <b>BARCODE / TAG</b> >, working with barcode and RFID tags; < <b>SINGLE TEST</b> >, test / measuring functions alone; < <b>EDIT APPLIANCE DATA</b> >, see <i>chapter 4.2.5</i> ; < <b>RECALL/DELETE/SEND MEMORY</b> >, working with results, see <i>chapter 7</i> ; < <b>UPLOAD DATA / EDIT LISTS / CHECK LOG</b> >, data transfer possibilities, see <i>chapter 7.5</i> ; < <b>SETUP</b> > the menu for general settings of the instrument, see <i>chapter 4.2.8</i> .
<b>ENTER</b>	Confirms selection.
<b>ESC</b>	Returns to the <b>Instrument main</b> menu.

### Note:

- The ESC key must be pressed more than once to return to **Main** menu from any submenu or selected function.

### 4.2.1 Autotest organizer menu

This menu offers creation and performing autotest sequences compatible with proper standards. The sequence setup and its parameters are exactly the same as suggested in the applied standard, VDE 0701-0702 or NEN 3140.

When an autotest sequence has been created in the autotest organizer, it can be run as an autotest or stored in the Custom Autotest menu.

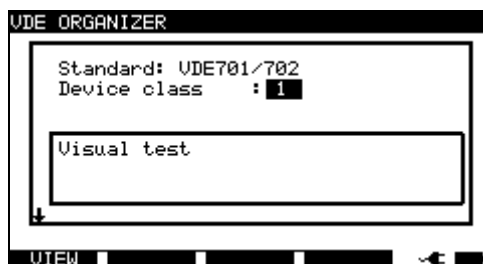

Autotest organizer menu

See chapter **6 Autotest sequences** for detailed description of this test mode.

## 4.2.2 Autotest custom menu

The menu contains a list of custom prepared autosequences.

Two sets (one for portable appliances and one for welding machines) of pre-programmed often used autotest sequences are added to the list by default.

Two sets of up to 50 custom autotest sequences can be pre-programmed in this autotest mode.

Custom autotests can be also downloaded to/ uploaded from the PC SW PATlinkPRO.



Autotest custom menu

– portable appliances



Autotest custom menu

– welding machines

See chapter **6 Autotest sequences** for detailed description about this test mode.

### Note:

- 3-Phase adapter A1422 combined with the SigmaGT instrument should be used for welding machine tests.

### 4.2.3 Project autotests menu

The Project autotest is a tool that simplifies and speeds up periodic testing of DUTs. The main idea is to re-use known and stored data about the DUT.



Project autotest starting menu example

See chapter 6.3 *Project autotests* for detailed description about this autotest mode.

### 4.2.3 Barcode / TAG menu

Barcode / TAG menu supports operation with barcodes, QR codes and RFID tags.

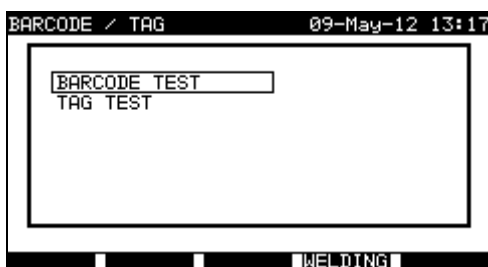

Autotest barcode/ tag menu – portable appliances

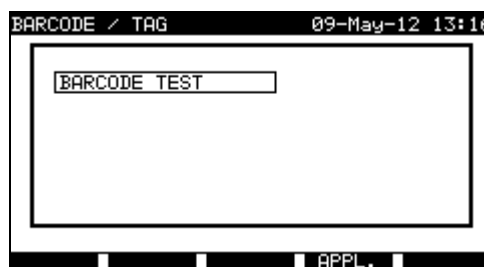

Autotest barcode menu – welding machines

See chapter 6.4 *Working with barcode / RFID tag* for more information.

### 4.2.4 Single test menu

In single test menu individual tests can be performed. Two single test menus are available (one for portable appliances and one for welding machines).

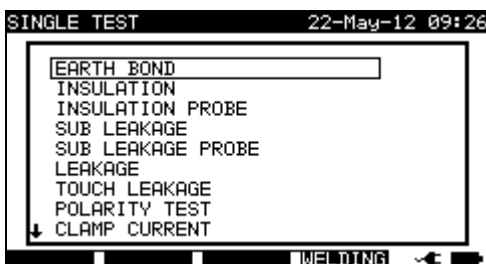

Single test menu – portable appliances

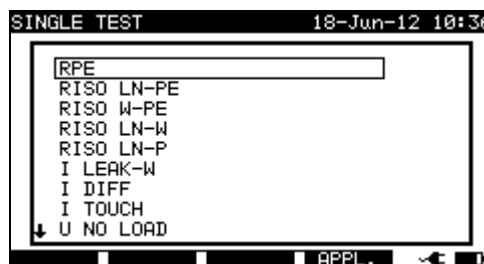

Single test menu – welding machines

See chapter **5 Single tests** for detailed description about the single test mode.

**Note:**

- 3-Phase adapter A1422 combined with the SigmaGT instrument should be used for welding machine tests.

## 4.2.5 Edit appliance data menu

In this menu lists of user and appliance data default names can be edited. An alternative is to upload the lists from PC.

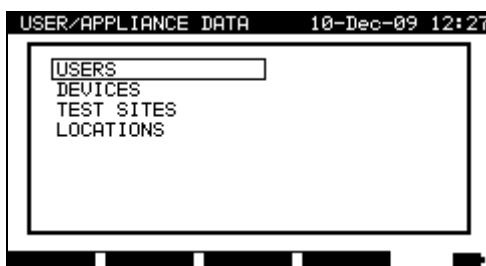

*Users / appliance data main menu*

Keys in user / device data menu:

<b>▲ / ▼</b>	Selects the field to be changed.
<b>ENTER</b>	Confirms selection and opens menu of selected item.
<b>ESC</b>	Returns to <b>Main</b> menu.

### 4.2.5.1 Users submenu

In this menu user names for up to 15 different users can be entered, edited and selected.

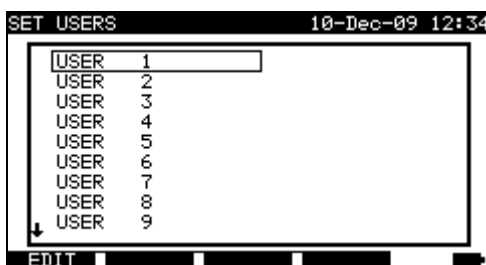

*Users submenu*

Keys in set users menu:

<b>▲ / ▼</b>	Selects the user.
<b>ENTER</b>	Confirms selection and returns to <b>User / device data</b> menu.
<b>EDIT (F1)</b>	Opens <b>Edit user</b> menu for selected user, see <b>4.2.5.1.1. Name editing menu</b> .
<b>ESC</b>	Discards modifications and returns to <b>User / appliance data</b> menu.

### 4.2.5.1.1 Item editing menu

The menu is intended for editing new/existing fields.

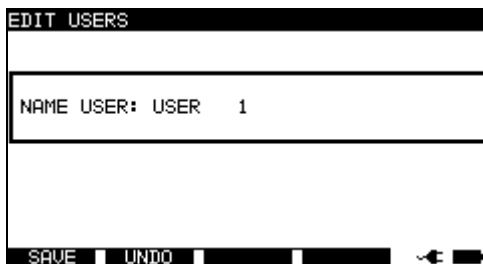

Item editing menu – example edit users

Keys in item editing menu:

Alphanumeric keys	Entering item name.
<b>SAVE</b> (F1)	Confirms entry and returns back.
<b>UNDO</b> (F2)	Discards modifications and recover original entry.
<b>ESC</b>	Discards modifications and returns back.

### 4.2.5.2 Device submenu

In this menu, default lists of device names (up to 100) can be edited. The list can be also downloaded to / uploaded from the PC SW PATLinkPRO. For more information refer to chapter **7.5 Data upload / download**.



Devices submenu

Keys in device menu:

<b>PgUp</b> (F2) / <b>PgDown</b> (F3)	Select the device.
<b>EDIT</b> (F1)	Opens <b>Edit device</b> menu, for selected device, see <b>4.2.5.1. Item editing menu</b> .
<b>ESC</b>	Discards modifications and returns to <b>User / appliance data</b> menu.



### 4.2.5.3 Test sites submenu

In this menu default lists of object names (up to 100) can be edited.  
The list can be also downloaded to/ uploaded from the PC SW PATlinkPRO.  
For more information refer to chapter **7.5 Data upload / download**.



*Test sites submenu*

Keys in test sites menu:

▲ / ▼ <b>PgUp (F2) / PgDown (F3)</b>	Selects the test site.
<b>EDIT (F1)</b>	Opens <b>Edit test site</b> menu for selected test site, see <b>4.2.5.1 Item editing menu</b> .
<b>ESC</b>	Discards modifications and returns to <b>User / appliance data</b> menu.

### 4.2.5.4 Locations submenu

In this menu default lists of location names (up to 100) can be edited.  
The list can be also downloaded to or uploaded from the PC SW PATlinkPRO.  
For more information refer to chapter **7.5 Data upload / download**.

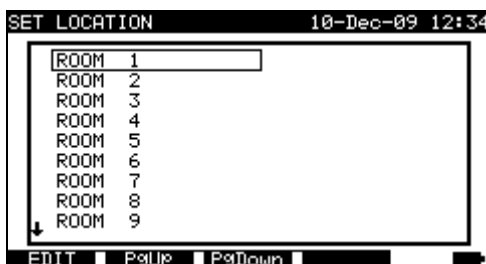

*Locations submenu*

Keys in device menu:

▲ / ▼ <b>PgUp (F2) / PgDown (F3)</b>	Selects the location.
<b>EDIT (F1)</b>	Opens <b>Edit location</b> menu for selected location, see <b>4.2.5.1 Item editing menu</b> .
<b>ESC</b>	Discards modifications and returns to <b>User / appliance data</b> menu.

## 4.2.6 Recall / delete / send memory menu

Manipulation with stored data is allowed in this menu. Stored results can be recalled according to DUT name and date, deleted or send to PC or printers.

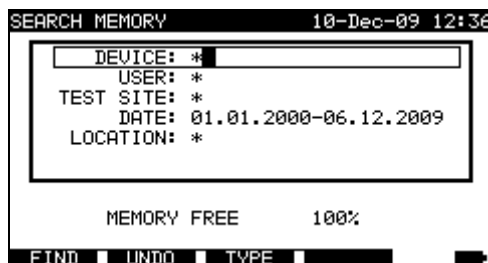

*Recall results menu*

See chapters **7.2 Recalling results**, **7.3 Deleting results** and **7.4 Downloading and printing results** for more information.

## 4.2.7 Upload data / edit lists / check log menu

In this menu it is possible to upload different data from PC to the instrument:

- Stored test results and data (results, parameters, notes),
- List of default DUT and test site names,
- List of custom autosequences.



*Upload of test data menu*

See chapter **7.5 Data upload / download** for detailed description about uploading / downloading data from or to a PC.

## 4.2.8 Setup menu

In the **Setup** menu the parameters of the instrument can be viewed or set.

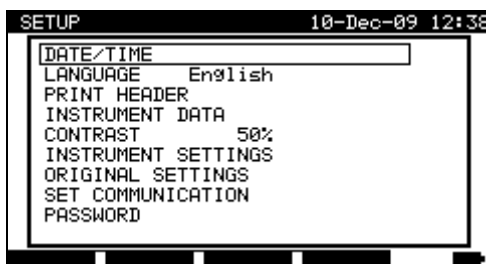

Setup menu

Keys in **Setup** menu:

<b>▲ / ▼</b>	Selects the setting to adjust or view: < <b>DATE/TIME</b> >, day and time, see 4.2.8.1; < <b>LANGUAGE</b> >, instrument language, see 4.2.8.2; < <b>PRINT HEADER</b> >, printed header options, see 4.2.8.3; < <b>INSTRUMENT DATA</b> >, data related to the SigmaGT, see 4.2.8.4; < <b>CONTRAST</b> >, LCD contrast, see 4.2.8.5; < <b>INSTRUMENT SETTINGS</b> >, various instrument settings, see 4.2.8.6; < <b>ORIGINAL SETTINGS</b> >, reset the instrument to factory settings, see 4.2.8.7; < <b>SET COMMUNICATION</b> >, communication parameters, see 4.2.8.8 and 4.2.8.9; < <b>PASSWORD</b> >, to access restricted options, see 4.2.8.10. < <b>CHECKBOX</b> >, to access calibration unit (optional), see 4.2.8.11.
<b>ENTER</b>	Confirms selection.
<b>ESC</b>	Returns to <b>Main</b> menu.

#### 4.2.8.1 Setting date and time

Selecting this option will allow the user to set the date and time of the unit. The following menu will be displayed:

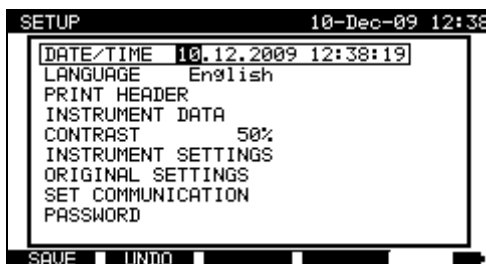

Date and time menu

Keys in date/time menu:

<b>◀ / ▶</b>	Selects the field to be changed.
<b>▲ / ▼</b>	Modifies selected field.
<b>SAVE (F1)</b>	Confirms selection and returns to <b>Setup</b> menu.
<b>UNDO (F2)</b>	Discards modifications and recover original entry.
<b>ESC</b>	Discards modifications and returns to <b>Setup</b> menu.

**Notes:**

- Date is attached to each PAT autotest measurement results!
- Date format is DD-MM-YYYY (day-month-year).
- Date entry is checked for regularity and is not accepted in case of irregular date!

**4.2.8.2 Language selection**

Selecting this option will allow the user to select the language in the instrument. The following menu will be displayed:

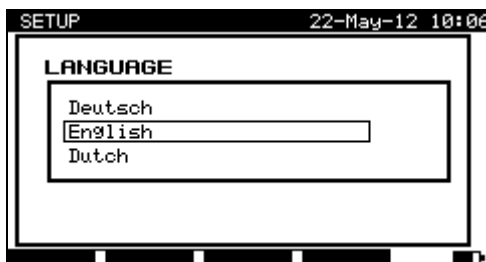

*Language menu*

Keys in Language menu:

▲ / ▼	Selects the language.
<b>ENTER</b>	Confirms selection and returns to <b>Setup</b> menu.
<b>ESC</b>	Discards modifications and returns to <b>Setup</b> menu.

**4.2.8.3 Print header**

Selecting this option will allow the user to set text of printing header. The print header is appended to printout form when test results are printed using a serial printer.

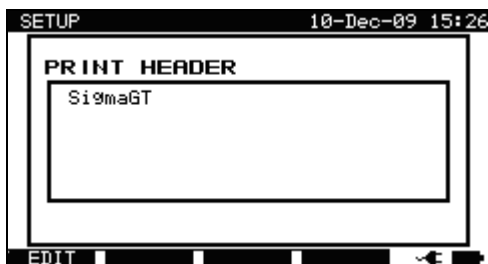

*Print header menu*



*Editing print header*

Keys in print header menu:

<b>EDIT (F1)</b>	Enters edit menu for entering print header.
<b>ESC</b>	Returns to <b>Setup</b> menu.

Keys in print header edit menu:

Alphanumeric keys	Entering header text
<b>SAVE (F1)</b>	Confirms selection and returns to <b>Setup</b> menu.
<b>UNDO (F2)</b>	Discards modifications and recover original entry.
<b>ESC</b>	Discards modifications and returns to <b>Setup</b> menu.

#### 4.2.8.4 Viewing of instrument data

In this menu the following instrument data are shown:

- Producer name,
- Instrument name,
- Calibration date,
- Serial number,
- Firmware version.

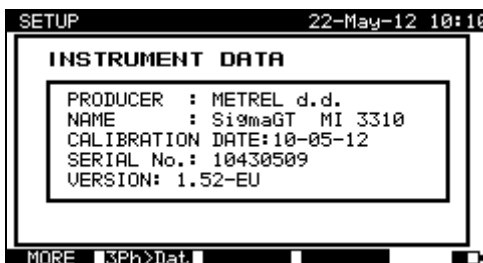

*Instrument data menu*

Keys in instrument data menu:

<b>MORE</b> (F1)	Switches between multiple screens.
<b>3Ph&gt;Dat</b> (F2)	Receives instrument data from 3-Phase adapter.
<b>ESC</b>	Returns to <b>Setup</b> menu.

**Note:**

- Operator cannot change any instrument data!

#### 4.2.8.5 Display contrast adjustment

Selecting this option will allow the user to set LCD contrast. The following menu will be displayed:

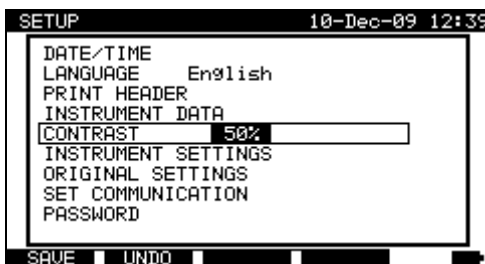

*Contrast menu*

Keys in contrast menu:

<b>▲ / ▼</b>	Modify contrast.
<b>SAVE</b> (F1)	Confirms selection and returns to <b>Setup</b> menu.
<b>UNDO</b> (F2)	Discards modifications and recover original entry.
<b>ESC</b>	Discards modifications and returns to <b>Setup</b> menu.

#### 4.2.8.6 Instrument settings

When an autotest is completed, different data about DUT and other associated data can be added to the autotest results before saving them. In the **Instrument settings** submenu, the various data and data types can be customized.

The following data can be controlled between tests:

- DUT number,
- Test site,
- Location,
- User,
- DUT name,
- Retest period,
- Repairing code,
- Comments,
- Barcode system,
- Save and Print,
- Last or worst result.

From the **Main** menu, select **Setup** and then select **Instrument settings** by using  $\wedge$  and  $\vee$  cursor keys and press ENTER key to confirm. The **Instrument settings** submenu will be displayed.

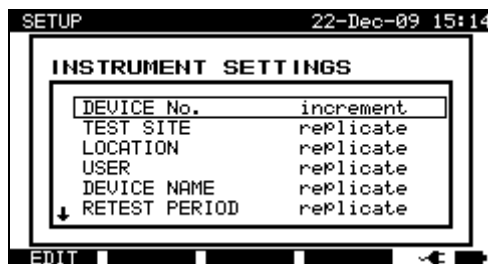

*Instrument settings menu*

Keys:

$\vee$ / $\wedge$	Selects the item whose parameter will be changed.
<b>EDIT (F1)</b>	Highlights the parameter that can be changed.
<b>ENTER</b>	
<b>ESC</b>	Returns to main settings menu.

#### Changing the instrument parameter

The selected parameter is highlighted.

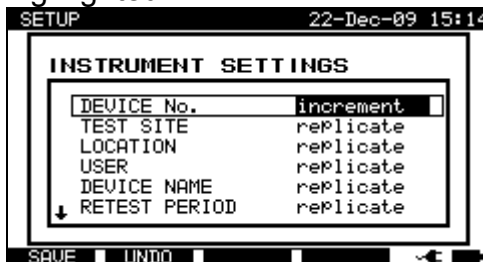

*Modification of selected setting*

Keys:

▼ / ▲	Modifies highlighted parameter.
<b>SAVE</b> (F1)	Saves setting of selected item,
<b>UNDO</b> (F2)	Recovers currently modified setting.
<b>ESC</b>	Returns to main settings menu.

**Notes:**

- If blank is selected for a particular item, then the appropriate field will initially appear blank in the Save results menu.
- If replicate option is selected for a particular item, the last entered data will initially appear in an appropriate field when new autotest sequence is finished.
- The increment option can also be set in the device number field. In this case, the DUT number will be automatically incremented when new autotest sequence is finished.
- Special character »\$« between autotest shortcut code and DUT name (ID number) is used to distinguish shortcut code from DUT name.
- Only DUT ID is printed out on the 2<sup>nd</sup> DUT label (power supply cord label).
- Refer to Appendix B for more information about barcode systems.

#### 4.2.8.7 Reset instrument settings

In this menu the following parameters can be set to their initial values:

- All measurement parameters in single test mode,
- User defined tests are cleared,
- Custom autotest sequences are replaced by factory pre-programmed ones,
- PC baud rate is set to 115200 bps,
- Printer protocol is set to hardware handshaking – flow control (DTR).

The following menu is displayed:



*Original settings menu*

Keys in instrument settings menu:

<b>Y</b>	Confirms reset to default values and returns to <b>Setup</b> menu.
<b>N</b>	Returns to <b>Setup</b> menu without reset.

#### 4.2.8.8 Communication settings

In this menu, the communication port (RS232, USB or Bluetooth) for communication with external devices (PC, scanner, printer, Android mobile device) can be set. Also baud rate for communication with PC can be set. Following menu will be displayed:

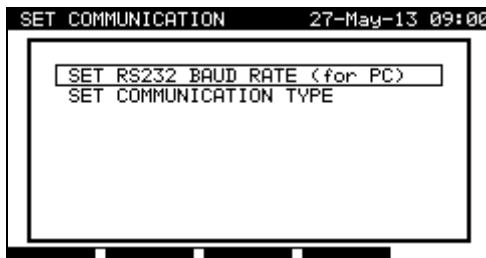

Communication menu

Keys in set communications menu:

▲ / ▼	Selects option.
ENTER	Confirms selection and opens menu of selected option.
ESC	Returns to <b>Setup menu</b> .

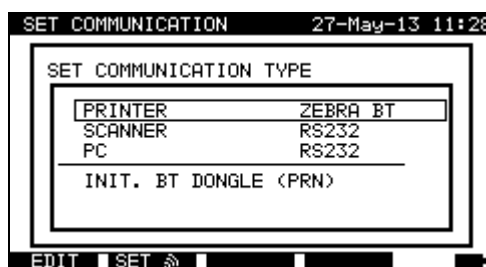
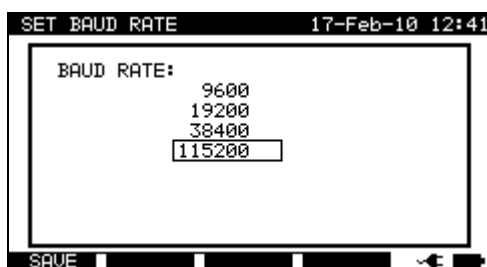

Communication settings

Keys in baud rate menu:

▲ / ▼	Selects the proper option.
SAVE (F1)	Confirms selection and returns to <b>Set communication menu</b> .
ESC	Returns to <b>Set communication menu</b> without changes.

Keys in set communication type menu:

▲ / ▼	Selects the option to be set. Selects initialization of Metrel Bluetooth dongle A 1436 for printer (offered if dongle is needed for selected option).
EDIT (F1)/ ENTER	Enters selection of device and communication type. Starts initialization of Bluetooth dongle A1436 (offered if dongle is needed for selected option).
SET BT (F2)	Searching for external Bluetooth devices and pairing them with the instrument, see chapter <i>Wireless (Bluetooth) communication setup</i> for more information.
ESC	Returns to <b>Set communication menu</b> .

Keys in selection of device and communication type:



▲ / ▼	Selects the proper device and communication type.
<b>SAVE</b> (F1)	Confirms selection and returns to <b>Set communication type</b> menu.
<b>UNDO</b> (F2) <b>ESC</b>	Returns to <b>Set communication type</b> menu without changes.

### Initialization of Bluetooth dongle A1436 (MI 3310 25A only)

If Zebra BT is selected as printer the Metrel Bluetooth dongle A 1436 has to be connected to the printer in order to communicate with the instrument via Bluetooth.

The Bluetooth dongle A 1436 should be initialized when it is used with for the first time. During initialization the instrument sets the dongle parameters and name in order to communicate properly.

The initialization procedure of the Bluetooth dongle (for the printer) is following:

1. Connect printer's Bluetooth dongle A 1436 to the instrument's RS 232 BARCODE port (via RS-232 to PS2 adapter).
2. Switch on the instrument.
3. Press RESET key on the Bluetooth dongle A 1436 for **at least 10 seconds**.
4. Select INIT. BT DONGLE (PRN) in Set communication type menu and press ENTER.
5. Wait for confirmation message and beep. Following message is displayed if dongle was initialized properly:  

EXTERNAL BT DONGLE SEARCHING OK!
6. Connect the successfully initialized Bluetooth dongle A 1436 to the printer (via RS-232 to PS2 adapter).

#### Notes:

- Only one communication port can be active at one time.
- Baud rates for communication with printers, scanners barcode readers and mobile devices are predefined and cannot be changed.
- Bluetooth communication can also be used for wireless communication between PC and instrument (firmware release 1.83 and up). If an authentication on PC side is required, enter 'NNNN' or '0000' pass key (PIN code) for Metrel Bluetooth Module.

### Wireless (Bluetooth) communication setup (MI 3310 25A only)

First **SET BT** in **Set communication** menu should be selected by using **F2 key**. The following menu is displayed.



*Edit Bluetooth device menu*

<b>SEARCH (F2)</b>	Searches for Bluetooth devices within the range.
--------------------	--

Once Bluetooth devices were found, instrument displays their names and Bluetooth addresses. Up to 6 Bluetooth devices can be displayed.

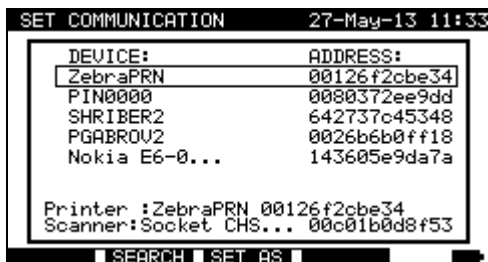

List of detected Bluetooth devices

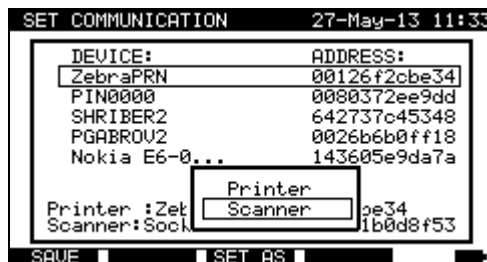

Set selected Bluetooth device as printer or scanner

<b>SEARCH (F2)</b>	Searches again for Bluetooth devices within the range.
<b>▲ / ▼</b>	Selects Bluetooth device to be paired with instrument.
<b>SET AS (F3)</b>	Selected Bluetooth device can be set as printer or scanner. Use ▲ / ▼ keys for selection.
<b>SAVE (F1), ENTER</b>	Confirms selected option in SET AS sub-menu.
<b>ESC</b>	Returns to <i>Edit Bluetooth device</i> or <i>Set Communication</i> menu.

When Bluetooth devices were set, they can communicate with the instrument using Bluetooth technology if communication type for printer and/or scanner is set to Bluetooth (Refer to paragraph **4.2.8.8 Communication settings**).

**Notes:**

- Using Bluetooth communication the following devices are supported: printer **O’Neil MF2te Bluetooth**, barcode reader **Socket mobile CHS 7E2**, printer **Zebra LP2824** (via Bluetooth dongle A 1436).
- For Bluetooth communications with Android mobile devices and PCs the Bluetooth settings must be set on the mobile device / PC.

**4.2.8.9 Password**

In password protected actions, it is necessary to enter the password before deleting or editing the protected data. The instrument requires a password and it will not allow changes unless the correct password has been entered.



Password menu

Keys in password menu:

Alphanumeric keys	Entering password.
<b>ENTER</b>	Accepts the password* and returns to <b>Setup</b> menu.
<b>ESC</b>	Discards modifications and returns to <b>Setup</b> menu.

Please take a note of this password and keep it in a safe place.

**Notes:**

- If there is no password protection, the instrument will request that you enter a new password twice, once to confirm.
- If the instrument is already password protected, then the instrument will request the old password before entering the new one twice, once to confirm.
- To disable the password protection, instead of entering a new password just press the ENTER key when asked for a new password and confirmation and the password will be disabled.

Contact your dealer if password is forgotten.

Password protected actions:

- Entering Edit user menu,
- Editing measurement parameters in single / autotest custom test mode,
- Deleting stored results,
- Entering Original settings menu.

#### 4.2.8.10 Calibration unit – checkbox (optional)

The in-built Checkbox provides a simple and effective means of checking the calibration of the SigmaGT instrument and accessories. According to the Code of Practice the ongoing accuracy of the PAT tester should be verified at regular intervals and recorded. This is of special importance if the PAT tester is used on a daily basis. The SigmaGT includes an in-built calibration unit ('Checkbox') that is independent from the other instrument's electronic circuitry. During the calibration with the in-built Checkbox all main instrument functions and accessories can be verified. The calibration results are automatically stored into the instrument's memory and can be viewed with the PATLink PRO PC software.

**Note:**

- › The Checkbox feature should be used to ensure that the meter is reading correctly between calibrations but should not be regarded as a substitute for a full manufacturers calibration on the unit.

The Checkbox starting screen is displayed first. In the REFERENCE column the Checkbox reference values are displayed.

CHECKBOX		09-Sep-10 13:46	
FUNCTION	REFERENCE	RESULT	STATUS
EARTH BOND	0.42Ω	-----Ω	
EARTH BOND	4.70Ω	-----Ω	
EARTH BOND 10A	0.42Ω	-----Ω	
EARTH BOND 10A	4.70Ω	-----Ω	
INSULATION	1.20MΩ	-----MΩ	
INSULATION	10.00MΩ	-----MΩ	
↓INSULATION S	1.20MΩ	-----MΩ	

CHECKBOX		09-Sep-10 13:46	
FUNCTION	REFERENCE	RESULT	STATUS
↑SUB LEAKAGE S	0.45mA	-----mA	
SUB LEAKAGE S	3.38mA	-----mA	
LEAKAGE	0.45mA	-----mA	
LEAKAGE	3.38mA	-----mA	
TOUCH LEAKAGE	0.45mA	-----mA	
TOUCH LEAKAGE	0.90mA	-----mA	
POLARITY			

Checkbox starting screen

Keys:

<b>START</b>	Starts instrument calibration procedure.
<b>▲ / ▼</b>	Switches between Checkbox screens.
<b>ESC</b>	Returns back to Setup menu without changes.

### Carrying out the instrument calibration

The checkbox instrument calibration starting screen is displayed first. Before conducting calibration, connect accessories as displayed.

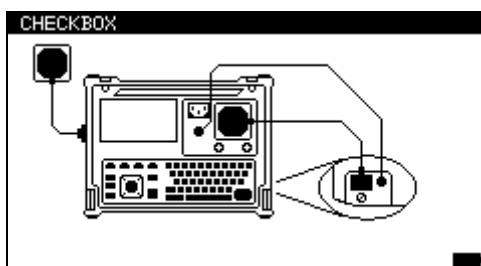

Instrument calibration starting screen

Keys:

<b>START</b>	Starts instrument calibration procedure.
<b>ESC</b>	Skips calibration procedure.

### Checking the IEC test cord

The connection for checking the IEC test cord is displayed. Before conducting the check, connect the IEC test cord.

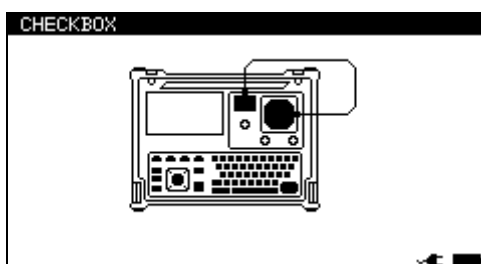

IEC test cord check starting screen

Keys:

<b>START</b>	Starts IEC test cord checking procedure.
<b>ESC</b>	Skips IEC test cord check.

After all steps were carried out the measured values together with an overall indication are displayed.

CHECKBOX		09-Sep-10 13:49		
FUNCTION	REFERENCE	RESULT	STATUS	
↑SUB LEAKAGE S	0.45mA	0.46mA	✓	
SUB LEAKAGE S	3.38mA	3.48mA	✓	
LEAKAGE	0.45mA	0.46mA	✓	
LEAKAGE	3.38mA	3.41mA	✓	
TOUCH LEAKAGE	0.45mA	0.47mA	✓	
TOUCH LEAKAGE	0.90mA	0.93mA	✓	
POLARITY			✓	

Example of Checkbox result screen

Meaning of indications:

- ✓ Accuracy of result is inside the given accuracy limits.
- ✘ **Warning:**  
The accuracy of the instrument lies out of specified limits!

Keys:

▲ / ▼	Displays all calibration results.
<b>START</b>	Starts new calibration procedure.
<b>ESC</b>	Returns to Setup menu.

## 5 Single tests

In the single test mode two sets of individual tests can be performed:

- › Single tests for appliances,
- › Single tests for welding machines.

This is especially helpful for troubleshooting.

### Notes:

- Single test results cannot be saved.
- For testing 3-phase appliances or welding machines the 3-phase operation mode must be enabled and the SigmaGT must be connected to a Metrel 3-phase adapter:
  - A1322 – for 3-phase appliances,
  - A1422 – for 3-phase appliances and single phase or 3-phase welding machines.

### 5.1 Performing measurements in single test mode

Select **Single test** in **main** menu by using  $\blacktriangle$  and  $\blacktriangledown$  keys and press **ENTER** key to confirm. The **Single test** menu is displayed.

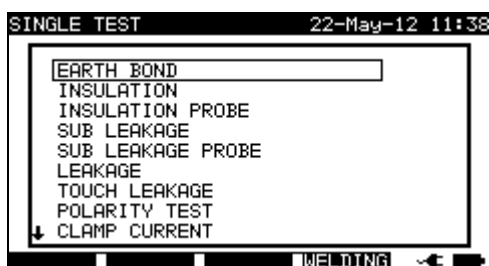

Single test menu – portable appliances

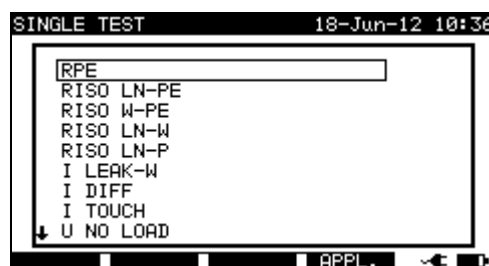

Single test menu – welding machines

Press (F4) **WELDING** or **APPL.** to switch between the two sets of single tests. (if applicable)

In **Single test** menu select single test by using  $\blacktriangle$  and  $\blacktriangledown$  keys and press **ENTER** key to confirm.

### Editing test parameters

Test measurement parameters of the selected single test are displayed in the top right corner of the display.

They can be edited by pressing the **EDIT** (F1) button and selected with by  $\blacktriangle$  and  $\blacktriangledown$  keys. The selected parameter is highlighted. Its value can be set by using  $\blacktriangleleft$  and  $\blacktriangleright$  keys.

### Note:

- To keep new settings, press the **SAVE** (F1) key.

## 5.2 Measurements – Single tests for appliances

### 5.2.1 Earth bond resistance

This test ensures that the connections between the protective conductor terminal in the mains plug of the DUT and earthed accessible conductive parts of the DUT (metal housing) are satisfactory and of sufficiently low resistance. This test has to be performed on Class 1 (earthed) DUT.

The instrument measures the resistance between mains test socket's PE terminal and EB/S terminal.

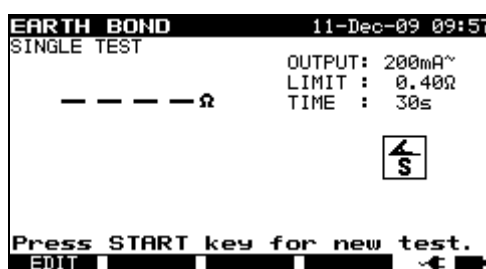

*Earth bond menu*

#### Test parameters for earth bond resistance measurement

OUTPUT	<b>Test current</b> [200 mA, 10 A, 25 A]
LIMIT	<b>Maximum resistance</b> [0.1 Ω ÷ 0.9 Ω, 1 Ω ÷ 9 Ω]
TIME	<b>Measuring time</b> [2 s, 3 s, 5 s, 10 s, 30 s]

#### Test circuit for earth bond resistance measurement

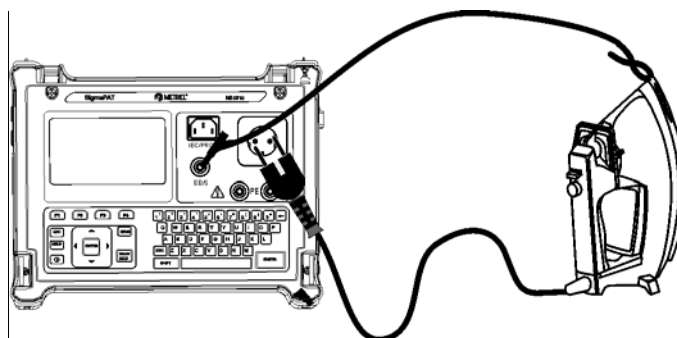

*Measurement of earth bond resistance of class I DUT*

#### Earth bond resistance measurement procedure

- Select the **EARTH BOND** function.
- Set test **parameters**.
- Connect** device under test to the instrument.
- Connect** test lead to EB/S output on the instrument.
- Connect** EB/S lead to accessible metal parts of the device under test (see figure above).
- Press the **START** key for measurement.

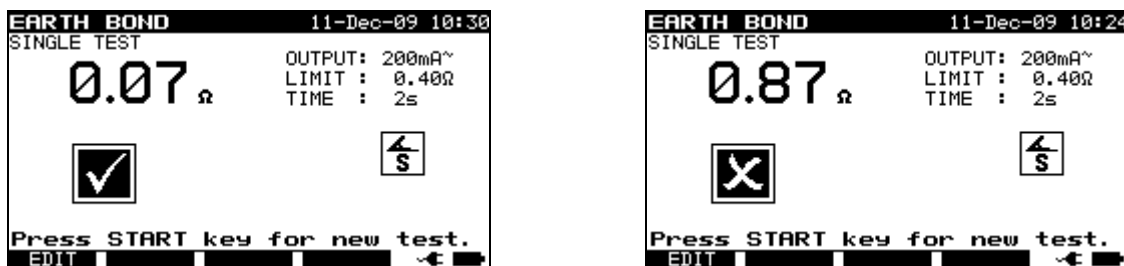

Examples of earth bond resistance measurement results

Displayed results:

Main result ..... earth bond resistance

**Note:**

- Consider displayed warnings before starting measurement!

### 5.2.1.1 Compensation of test leads resistance (firmware release 1.24 and up)

Test leads compensation is required to eliminate the influence of test leads resistance and instrument's internal resistance. If a compensation value is stored this is indicated in the message **C**.

Compensation of test leads resistance procedure

- Select the **Earth Bond** function.
- Set test **parameters**.
- Connect** EB/S test probe to the instrument and short it with PE pin of test socket.
- Press the CAL (F3)** key for measurement.
- If the calibration was performed successfully, result 0.00 Ω is displayed.

**Notes:**

- 5.00 Ω is the limit value for resistance compensation. If the resistance is higher than the calibration value is reset to the default value and the compensation message disappears.
- All (200 mA, 10 A and 25 A) earth bond functions are compensated at the same time.
- The lead compensation is very important to obtain correct results especially if long test leads are used.

### 5.2.2 Insulation resistance

The insulation resistance test checks the resistance between live conductors and accessible conductive parts of the DUT connected to PE or isolated. This test can disclose faults caused by pollution, moisture, deterioration of insulation material etc.

The instrument measures the insulation resistance between:

- Mains test socket (L+N, +) and PE / (EB/S, -) test terminals, and
- LN and PE / (EB/S) test outputs.

This function is primarily intended for testing Class I DUTs.





*Insulation menu*

### Test parameters for insulation resistance measurement

OUTPUT	<b>Test voltage</b> [250 V, 500 V]
LIMIT	<b>Minimum resistance</b> [0.01 MΩ, 0.10 MΩ, 0.25 MΩ, 0.30 MΩ, 0.50 MΩ, 1.00 MΩ, 2.00 MΩ, 4.00 MΩ, 7.00 MΩ, 10.0 MΩ, none]
TIME	<b>Measuring time</b> [2 s, 3 s, 5 s, 10 s, 30 s, 60 s, 120 s, 180 s, none]

**Test circuits for insulation resistance measurement**

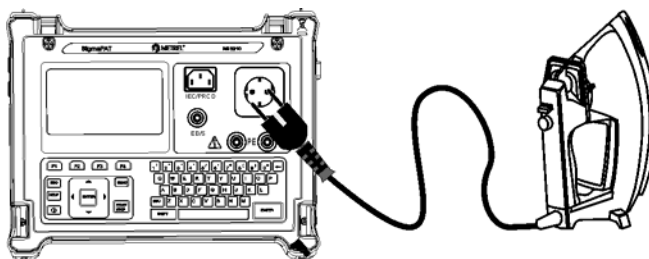

*Measurement of insulation resistance of Class I DUT*

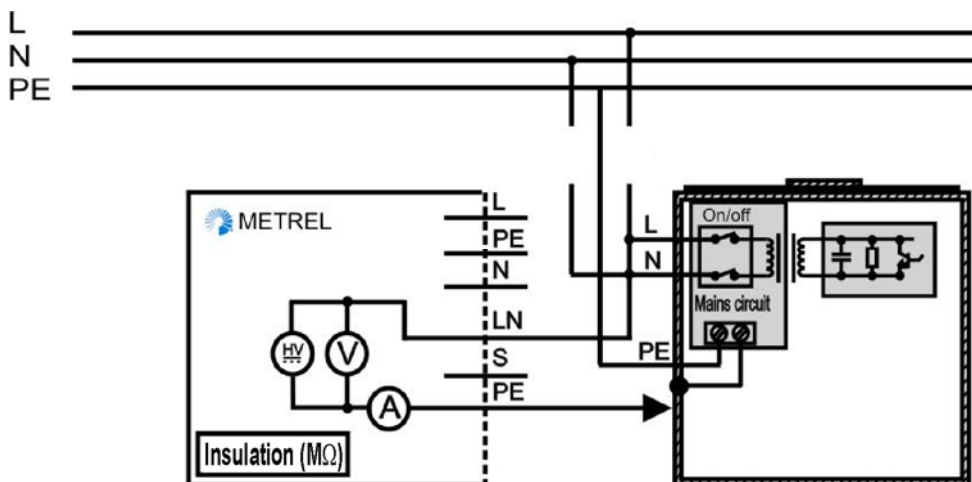

*Measurement of insulation resistance of fixed installed DUTs of Class I*

**Insulation resistance measurement procedure**

- Select the **Insulation** function.
- Set test **parameters**.
- Connect** device under test to the instrument (see figures above).
- For **fixed** equipment:
  - Disconnect mains** supply of the fixed equipment;
  - Connect LN** test socket of the instrument to L/N terminals of the fixed equipment;
  - Connect PE** test socket of the instrument to metallic enclosure of the fixed equipment.
- Press the **START** key for measurement.



Examples of *insulation* resistance measurement results

Displayed results:

Main result ..... Insulation resistance

**Notes:**

- Leakage currents into the EB/S and PE test inputs will influence insulation resistance measurement.
- When EB/S or PE probes are connected during the test then the current through them is also considered.
- The DUT should be de-energized before the measurement!
- Consider any warning on the display before starting the measurement!
- Do not touch or disconnect the DUT during the measurement or before it is fully discharged! The message »Discharging...« will be displayed while the voltage on the DUT is higher than 20 V!

**5.2.3 Insulation resistance – S probe**

The insulation resistance test checks the resistance between live conductors and isolated accessible metal parts of DUT. This test can disclose faults caused by pollution, moisture, deterioration of insulation material etc.

The instrument measures the insulation resistance between:

- Main test socket (L+N, +) and EB/S (-) test terminals, and
- LN (+) and EB/S (-) test sockets.

This function is primarily intended for testing Class II DUTs and Class II parts of Class I DUTs.

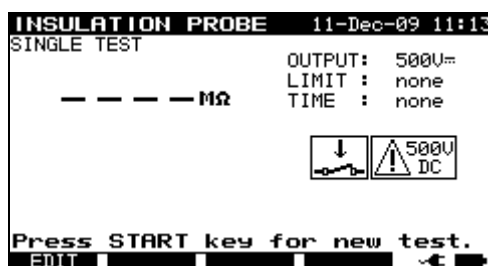

*Insulation – S probe menu*

**Test parameters for insulation resistance measurement**

OUTPUT	<b>Test voltage</b> [250 V, 500 V]
LIMIT	<b>Minimum resistance</b> [0.01 MΩ, 0.10 MΩ, 0.25 MΩ, 0.30 MΩ, 0.50 MΩ, 1.00 MΩ, 2.00 MΩ, 4.00 MΩ, 7.00 MΩ, 10.0 MΩ, none]
TIME	<b>Measuring time</b> [2 s, 3 s, 5 s, 10 s, 30 s, 60 s, 120 s, 180 s, none]

### Test circuits for Insulation - S resistance measurement

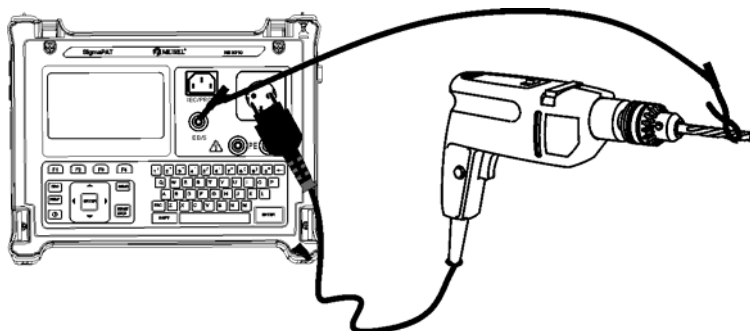

*Measurement of insulation resistance of class II DUT*

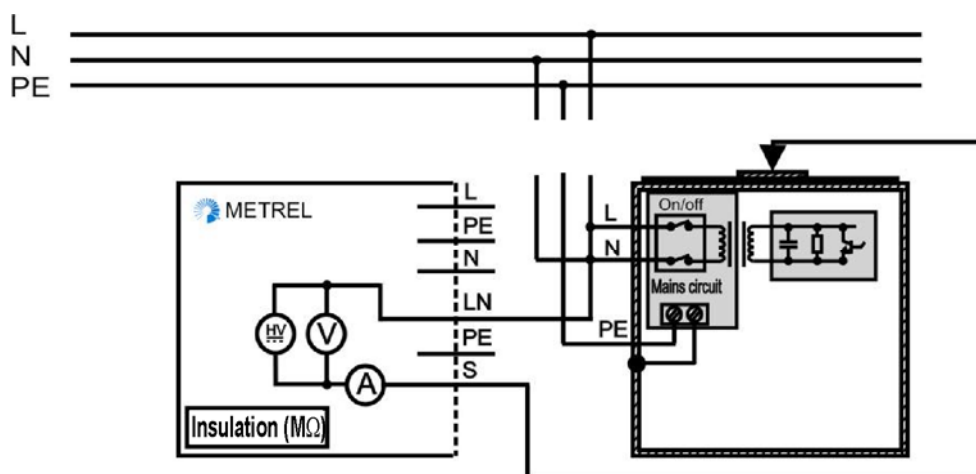

*Measurement of insulation resistance of accessible isolated conductive parts of fixed installed DUTs*

### Insulation resistance – S probe measurement procedure

- Select the **Insulation resistance-S probe** function.
- Set test **parameters**.
- Connect** device under test to the instrument (see figures above).
- Connect** EB/S probe to accessible conductive parts of the DUT.
- For **fixed equipment**:
  - Disconnect mains** supply of the fixed equipment;
  - Connect** LN test socket of the instrument to L/N terminals of the fixed equipment;
  - Connect** EB/S probe to accessible conductive parts of the fixed installed DUT
- Press the **START** key for measurement.

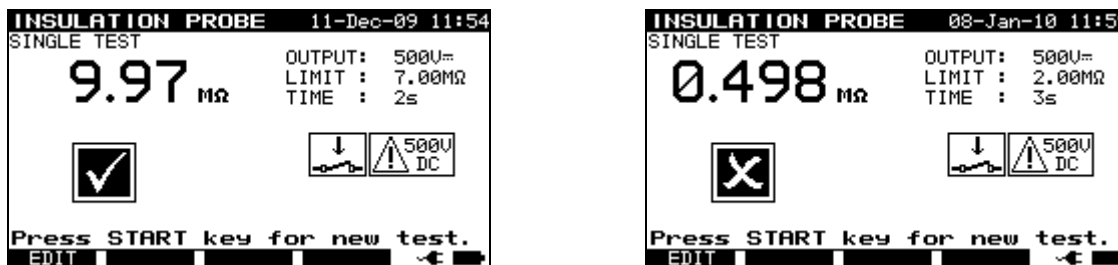

Example of insulation-S probe resistance measurement results

Displayed results:

Main result ..... Insulation resistance (LN – S)

**Notes:**

- If a Class I device is connected to the mains test socket the currents flowing through the PE terminal will not be considered.
- The DUT should be de-energized before the measurement!
- Consider any warning on the display before starting the measurement!
- Do not touch / disconnect the DUT during the measurement or before it is fully discharged! The message »Discharging...« will be displayed while the voltage on the DUT is higher than 20 V!

**5.2.4 Substitute leakage current**

Leakage currents between live conductors and accessible metal parts (housing, screws, handles etc.) are checked with this test. Capacitive leakage paths are included in the result too. The test measures the current flowing at a test voltage of 40 V AC and the result is scaled to the value of a nominal mains supply voltage of 230 V AC.

The instrument measures the insulation resistance between:

- Main test socket (L+N) and PE / (EB/S) test terminals, and
- LN and PE / (EB/S) test sockets.

This function is primarily intended for testing Class I DUTs.



Sub leakage menu

**Test parameters for substitute leakage current measurement**

OUTPUT	Test voltage [40 V]
LIMIT	<b>Maximum current</b> [0.25 mA, 0.50 mA, 0.75 mA, 1.00 mA, 1.50 mA, 2.25 mA, 2.50 mA, 3.50 mA, 4.00 mA, 4.50 mA, 5.00 mA, 5.50 mA, 6.00 mA, 7.00 mA, 8.00 mA, 9.00 mA, none]
TIME	<b>Measuring time</b> [2 s, 3 s, 5 s, 10 s, 30 s, 60 s, 120 s, 180 s, none]

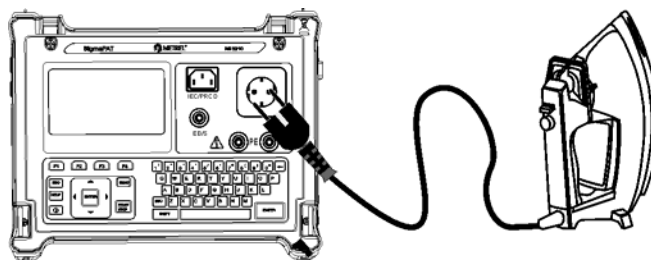

Measurement of substitute leakage current of class I DUT

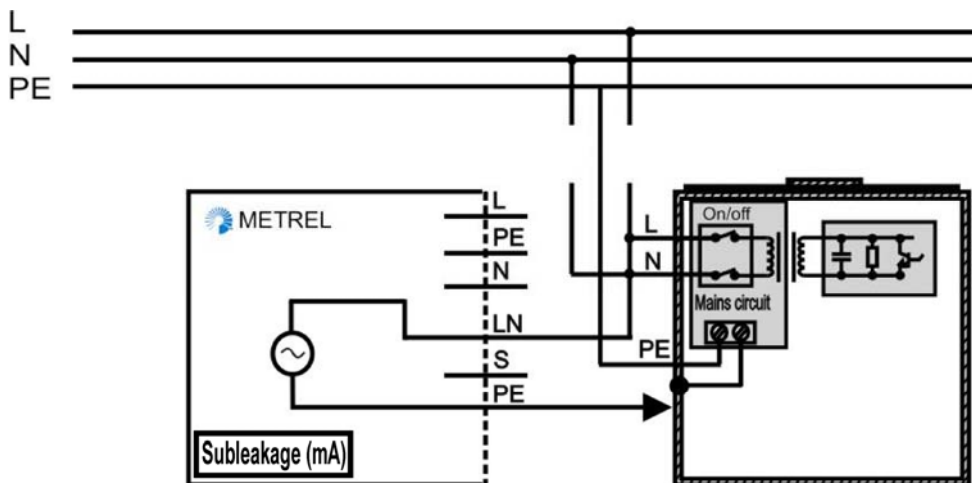

Measurement of substitute leakage current of fixed installed DUTs of class I

**Substitute leakage measurement procedure**

- Select the **Substitute leakage** function.
- Set test **parameters**.
- Connect** device under test to the instrument (see figures above).
- For **fixed equipment**:
  - Disconnect mains** supply of the fixed equipment;
  - Connect** LN test socket of the instrument to L/N terminals of the fixed equipment;
  - Connect** PE test socket of the instrument to metallic enclosure of the fixed equipment.
- Press the **START** key for measurement.



Example of substitute leakage current measurement results

Displayed results:  
 Main result ..... substitute leakage current

Notes:

- Consider any displayed warning before starting measurement!
- Leakage currents into the EB/S and PE test inputs will influence substitute leakage current measurement.
- When EB/S or PE probes are connected during the test then the current through them is also considered.
- Substitute leakage current may differ substantially from that of conventional leakage current test because of the way the test is performed. For example, the difference in both leakage measurements will be affected by the presence of neutral to earth noise suppression capacitors.

### 5.2.5 Substitute leakage – S probe

Leakage currents between live conductors and isolated accessible metal parts (screws, handles etc.) are checked with this test. Capacitive leakage paths are included in the result too. The test measures the current flowing at a test voltage of 40 V AC and the result is scaled to the value of a nominal mains supply voltage of 230 V AC.

The instrument measures the insulation resistance between:

- Main test socket (L+N) and EB/S test terminals, and
- LN and EB/S test sockets.

This function is primarily intended for testing Class II DUTs and Class II parts of Class I DUTs.



*Sub leakage – S probe menu*

#### Test parameters for substitute leakage – S probe current measurement

OUTPUT	Test voltage [40 V]
LIMIT	<b>Maximum current</b> [0.25 mA, 0.50 mA, 0.75 mA, 1.00 mA, 1.50 mA, 2.25 mA, 2.50 mA, 3.50 mA, 4.0 mA, 4.50 mA, 5.00 mA, 5.50 mA, 6.00 mA, 7.00 mA, 8.00 mA, 9.00 mA, none]
TIME	<b>Measuring time</b> [2 s, 3 s, 5 s, 10 s, 30 s, 60 s, 120 s, 180 s, none]

**Test circuits for substitute leakage –S probe measurement**

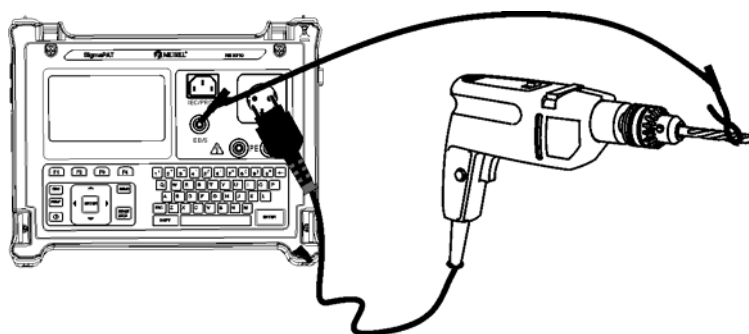

*Measurement of substitute leakage current of class II DUT*

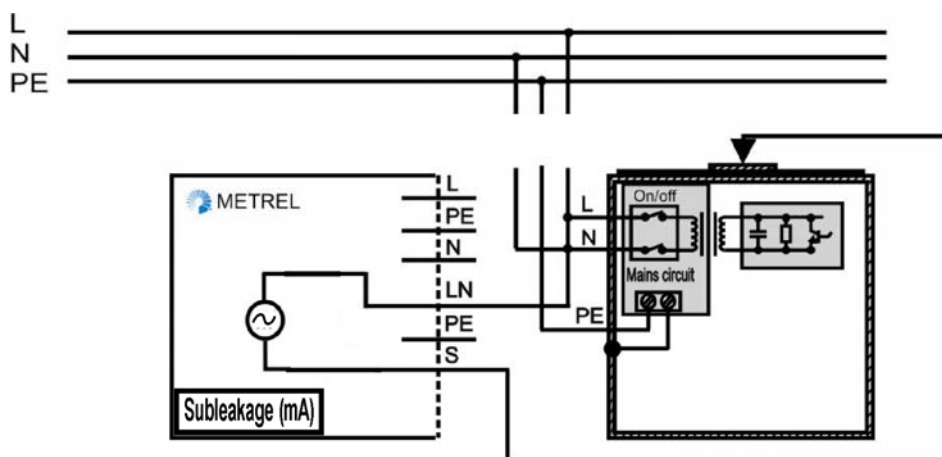

*Measurement of substitute leakage of accessible isolated conductive parts of fixed installed DUTs*

**Substitute leakage – S probe measurement procedure**

- Select the **Substitute leakage-S probe** function.
- Set test **parameters**.
- Connect** device under test to the instrument (see figures above).
- Connect** EB/S probe to accessible conductive parts of the DUT.
- For **fixed equipment**:
  - Disconnect mains** supply of the fixed equipment;
  - Connect** LN test socket of the instrument to L/N terminals of the fixed equipment;
  - Connect** EB/S probe to accessible conductive parts of the fixed installed DUT
- Press the **START** key for measurement.



*Example of substitute leakage S current measurement results*



Displayed results:

Main result ..... substitute leakage current LN-S

**Notes:**

- Consider any displayed warning before starting measurement!
- If a Class I device is connected to the mains test socket the currents flowing through the PE terminal will not be considered.

**5.2.6 Differential leakage current**

The purpose of this test is to determine the sum of all leakages flowing from the live conductor to the earth. Because the differential method for determining leakage current is used the full and true DUT leakage current is always measured, even when parallel current paths to ground exist in the DUT.



*Differential leakage current menu*

**Test parameters for differential leakage current measurement**

OUTPUT	System voltage [230 V]
LIMIT	<b>Maximum current</b> [0.25 mA, 0.50 mA, 0.75 mA, 1.00 mA, 1.50 mA, 2.25 mA, 2.50 mA, 3.50 mA, 4.00 mA, 4.50 mA, 5.00 mA, 5.50 mA, 6.00 mA, 7.00 mA, 8.00 mA, 9.00 mA, none]
TIME	<b>Measuring time</b> [2 s, 3 s, 5 s, 10 s, 30 s, 60 s, 120 s, 180 s, none]

**Test circuit for differential current measurement**

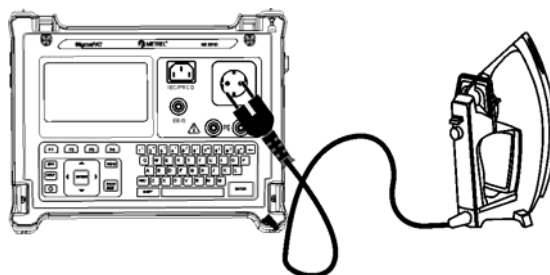

*Measuring of differential current*

**Differential current measurement procedure**

- Select the **Leakage function**.
- Set test **parameters**.
- Connect** device under test to the instrument (see figure above).
- Press the **START** key for measurement.

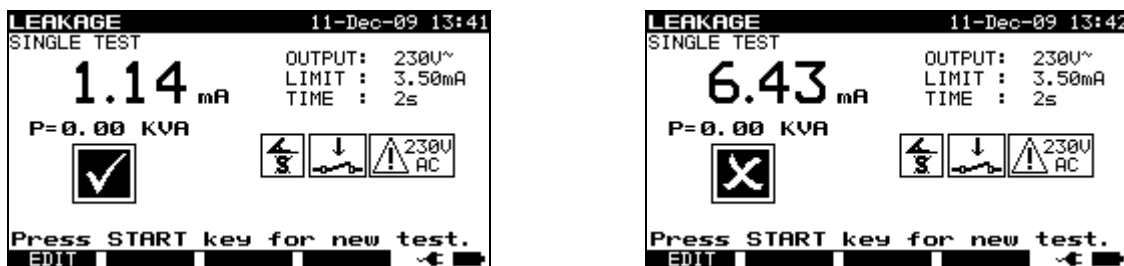

Examples of differential current measurement result

Displayed results:

Main result ..... differential leakage current

**Notes:**

- During the test, a mains voltage is connected to the DUT. If DUT contains moving parts, make sure that it is safely mounted or protected to prevent possible danger to the operator or damage to the DUT or surrounding environment!
- Consider any displayed warning before starting measurement!
- The instrument automatically changes L and N polarity of connected DUT during the test.

**5.2.7 Touch leakage current**

This test determines the current that would flow if a person touches accessible conductive parts of the DUT.

The instrument measures the leakage current flowing through the EB/S probe into earth.

The DUT can be powered from the mains test socket or directly from the installation (fixed installed equipment).



Touch leakage menu

**Test parameters for touch leakage current measurement**

OUTPUT	System voltage [230 V]
LIMIT	Maximum current [0.25 mA, 0.50 mA, 0.75 mA, 1.00 mA, 1.50 mA, 2.00 mA, 3.5 mA, none]
TIME	Measuring time [2 s, 3 s, 5 s, 10 s, 30 s, 60 s, 120 s, 180 s, none]

**Test circuits for touch leakage current measurement**

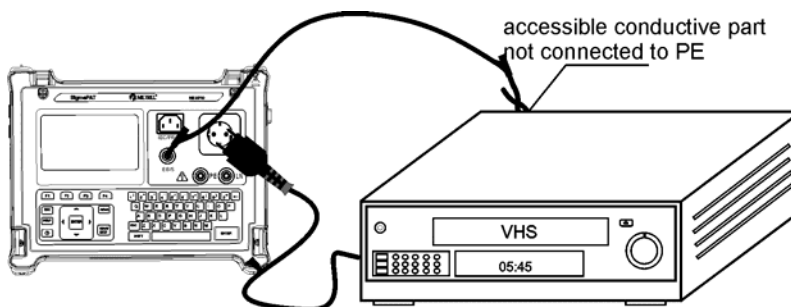

*Measurement of touch leakage current*

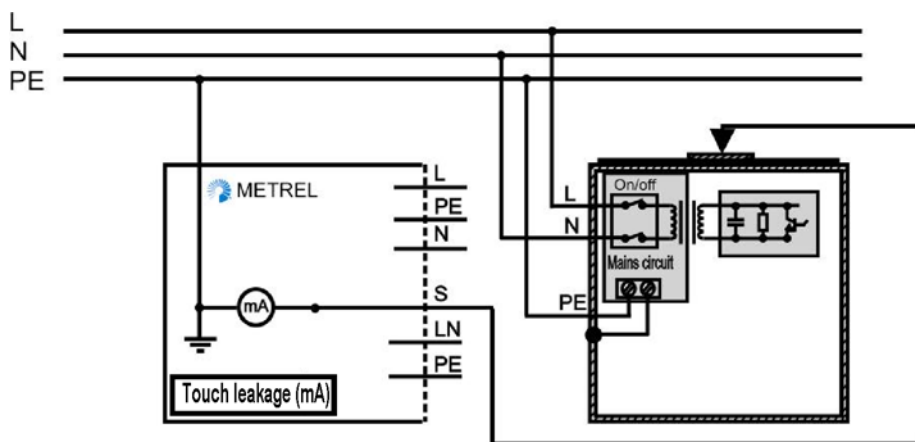

*Measurement of touch leakage current on a fixed installed DUT*

**Touch leakage current measurement procedure**

- Select the **Touch leakage** function.
- Set test **parameters**.
- Connect** EB/S probe to accessible conductive parts of the DUT (see figures above).
- For **Portable appliance/device**:
  - Connect** device under test to the instrument.
- For **fixed equipment**:
  - Power on** the fixed equipment;
- Press the **START** key for measurement.



*Examples of touch leakage current measurement results*

Displayed results:  
Main result ..... touch leakage current

**Notes:**

- During the test, a mains voltage is connected to the DUT. If DUT contains moving parts, make sure that it is safely mounted or protected to prevent possible danger to the operator or damage to the DUT or surrounding environment!
- Consider any displayed warning before starting measurement!
- The instrument automatically changes L and N polarity of connected DUT during the test.

**5.2.8 Polarity test**

In this test the polarity of supply cords/ leads is checked. In the Normal mode the test is performed with internal low voltage sources. The Active mode is intended to test cords/ leads with integrated RCD protection. Mains voltage is applied to the tested cord in order to operate the RCD during the test. Shorted, crossed and open wires are detected in this test.

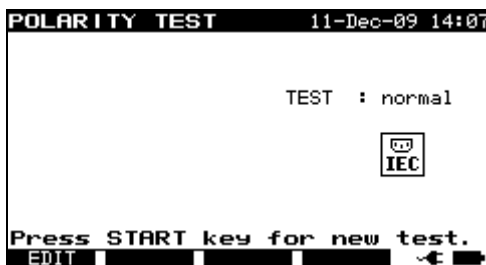

*Polarity test menu*

**Test parameters for polarity test**

TEST	Type of polarity test [normal, active]
------	--

**Test circuits for polarity test**

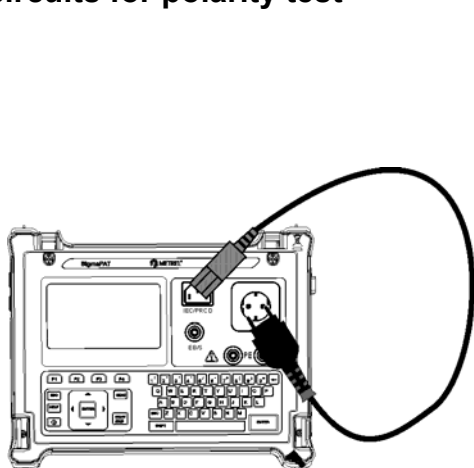

*Polarity test – normal for IEC cord*

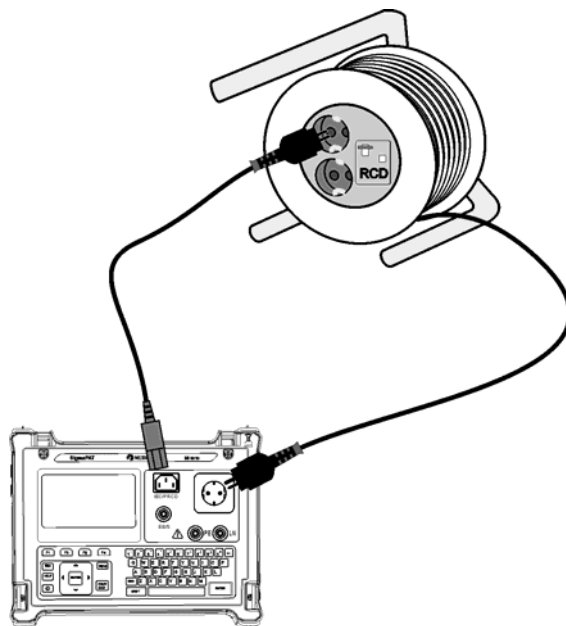

*Polarity test – active for RCD protected cord*

**Polarity - Standard test procedure**

- Select the **Polarity test** function.
- Select the **normal test** subfunction.
- Connect** tested IEC cord to the instrument (see figure above).
- Press the **START** key for measurement.

**Polarity - Active test procedure**

- Select the **Polarity test** function.
- Select the **active test** subfunction.
- Connect** tested IEC cord to the instrument (see figure above).
- Press the **START** key for measurement.
- Switch ON** the appliance (RCD) within 5 seconds and follow the instructions on the display.
- Switch ON** the RCD again if necessary.



*Examples of polarity test result*

Displayed results:

Main result ..... PASS/ FAIL, description of fault

**Notes:**

- Consider any displayed warning before starting test!
- Active polarity test is intended for testing RCD equipped cords where RCD must be supplied for proper operation.
- In the active polarity test a switchover between phase and neutral at the mains test socket is performed during the test. Although the switchover time is short it could happen that the RCD switches off during the switchover. In this case the warning 'SWITCH ON THE APPLIANCE' is displayed again and the RCD must be re-switched ON.
- When active polarity test is enabled in autotest sequence then mains supply voltage is applied on test socket during earth bond test (if selected in autotest sequence).

**5.2.9 Clamp current test**

This function enables the measurement of AC currents in a wide range from 0.1 mA up to 25 A with current clamps. Typical applications are:

- Measuring PE leakage currents through PE conductor in permanently installed DUTs,
- Measuring load currents in permanently installed DUTs,
- Measuring differential leakage currents in permanently installed DUTs.



*Clamp current menu*

### Test parameters for clamp current measurement

LIMIT	<b>Maximum current</b> [0.25 mA, 0.50 mA, 0.75 mA, 1.00 mA, 1.50 mA, 2.25 mA, 2.50 mA, 3.00 mA, 3.50 mA, 5.00 mA, 9.00 mA, none]
TIME	<b>Measuring time</b> [2 s, 3 s, 5 s, 10 s, 30 s, 60 s, 120 s, 180 s, none]

**Test circuit for clamp current measurement**

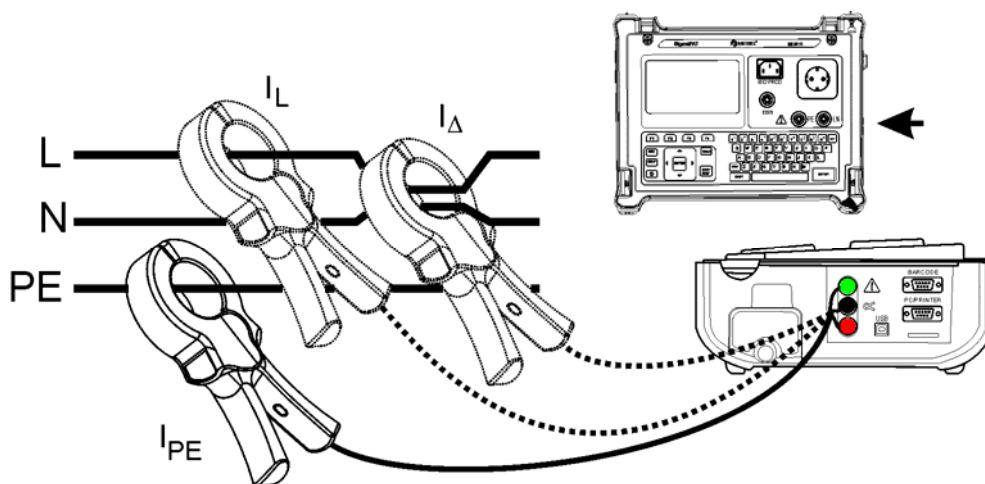

*Connecting current clamp to the instrument*

**Clamp current measurement procedure**

- Select the **Clamp current** function.
- Set test **parameters**.
- Connect** the current clamp to the instrument (see figure above).
- Embrace** wire(s) that has to be measured with current clamp.
- Press the **START** key for measurement.



*Examples of clamp current measurement result*

Displayed results:

Main result ..... clamp current

**Notes:**

- When measuring leakage currents, the neighboring magnetic fields and capacitive coupling (especially from the L and N conductors) can disturb the results. It is recommended that the clamp is as close as possible to the grounded surface and away from wires and other objects under voltage or carrying current.
- METREL offers high quality current clamps for this application.
- Green socket is intended for current clamp shield terminal, if exists. This will improve measurement of leakage current. The socket is connected to internal grounding system and through this to PE.

### 5.2.10 RCD/PRCD test

The purpose of this test is to ensure the proper operation of the following residual current devices:

- Installed in electrical installation and
- Portable residual current devices (PRCD).

Trip-out measurements verify the sensitivity of a RCD at selected residual currents.



RCD test - single test menu

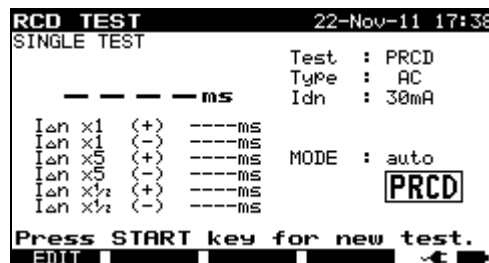

PRCD test - autotest menu

#### Test parameters for RCD/PRCD test

Test	Type of residual current device [RCD, PRCD]*
Type	RCD type: AC, A, B
$I_{\Delta N}$	Rated residual current [10 mA, 15 mA, 30 mA]
MODE	Type of RCD test [single, auto]

\* In following text RCD is applied as common word for both RCD and PRCD type devices. Both are mentioned only where difference exists.

If Single mode is selected:

Multi	Actual test current $I_{\Delta N}$ [ $\times \frac{1}{2}$ , $\times 1$ , $\times 5$ ] (trip-out time for AC and A RCD)
Phase	Starting angle [ $0^\circ$ , $180^\circ$ , ( $0^\circ, 180^\circ$ )] (for B type only $0^\circ$ and $180^\circ$ )

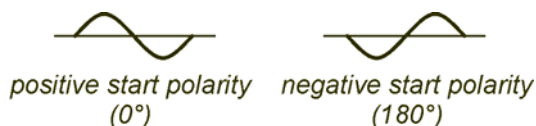

RCD test current starting polarities (shown for AC type current)

#### Trip-out time limits

Trip-out times according to EN 61540:

	$\frac{1}{2} \times I_{\Delta N}^*)$	$I_{\Delta N}$	$5 \times I_{\Delta N}$
General RCDs (non-delayed)	$t_{\Delta} > 300$ ms	$t_{\Delta} < 300$ ms	$t_{\Delta} < 40$ ms

\*) Minimum test period for current of  $\frac{1}{2} \times I_{\Delta N}$ , RCD shall not trip-out.

Maximum test times related to selected test current for general (non-delayed) RCD

Standard	$\frac{1}{2} \times I_{\Delta N}$	$I_{\Delta N}$	$5 \times I_{\Delta N}$
EN 61540	400 ms	400 ms	40 ms
PRCD	1999 ms	200 ms	40 ms
RCD	300 ms	300 ms	40 ms



**Circuits for testing RCD**

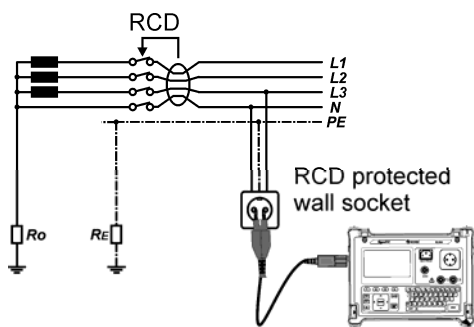

Testing of standard **RCD**

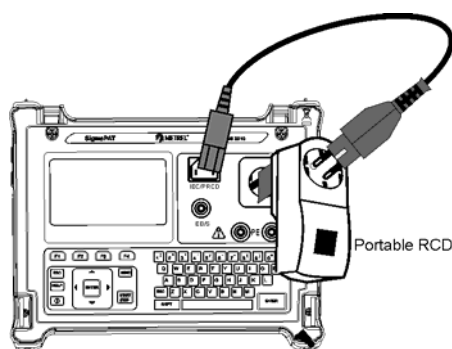

Testing of portable **RCD (PRCD)**

**5.2.10.1 RCD single test**

**Trip-out time/current measurement procedure**

- Select the **RCD test** function.
- Select **Single test** mode.
- Set test **parameters**.
- PRCD**: Connect tested PRCD between test socket on the SigmaGT and IEC appliance connector (see figure above). Depending on the type of PRCD, it may be necessary to manually switch it on.
- RCD**: Connect the SigmaGT main entry to socket protected by tested RCD (see figure above).
- Press the **START** key to perform measurement.
- If both current polarities are selected:
- Reactivate** tested RCD.



Examples of RCD test result

Displayed results:

Main result ..... last measured results

Sub-results ..... all results are displayed as sub-results

**5.2.10.2 Automatic RCD test**

RCD autotest function is intended to perform a complete RCD analysis (trip-out times at different residual currents and current phases for type AC and A RCDs and trip-out current for both current phases).

**RCD autotest procedure**

RCD Autotest steps	Notes
<ul style="list-style-type: none"> <li><input type="checkbox"/> Select the <b>RCD test</b> function.</li> <li><input type="checkbox"/> Set <b>Auto test</b> mode.</li> <li><input type="checkbox"/> Select test <b>parameters</b>.</li> <li><input type="checkbox"/> PRCD: Connect tested PRCD between test socket on the SigmaGT and IEC appliance connector (see figure above). Depending on the type of PRCD, it may be necessary to manually switch it on.</li> <li><input type="checkbox"/> RCD: Connect the SigmaGT main entry to socket protected by tested RCD (see figure above).</li> <li><input type="checkbox"/> Press the <b>START</b> key.</li> </ul>	Start of test
<input type="checkbox"/> Test with $I_{\Delta N}$ , 0° (step 1).	RCD should trip-out
<ul style="list-style-type: none"> <li><input type="checkbox"/> <b>Re-activate</b> RCD.</li> <li><input type="checkbox"/> Test with <math>I_{\Delta N}</math>, 180° (step 2).</li> </ul>	RCD should trip-out
<ul style="list-style-type: none"> <li><input type="checkbox"/> <b>Re-activate</b> PRCD.</li> <li><input type="checkbox"/> Test with <math>5 \times I_{\Delta N}</math>, 0° (step 3).</li> </ul>	RCD should trip-out
<ul style="list-style-type: none"> <li><input type="checkbox"/> <b>Re-activate</b> RCD.</li> <li><input type="checkbox"/> Test with <math>5 \times I_{\Delta N}</math>, 180° (step 4).</li> </ul>	RCD should trip-out
<ul style="list-style-type: none"> <li><input type="checkbox"/> <b>Re-activate</b> RCD.</li> <li><input type="checkbox"/> Test with <math>\frac{1}{2} \times I_{\Delta N}</math>, 0° (step 5).</li> </ul>	RCD should not trip-out
<input type="checkbox"/> Test with $\frac{1}{2} \times I_{\Delta N}$ , 180° (step 6).	RCD should not trip-out End of test.

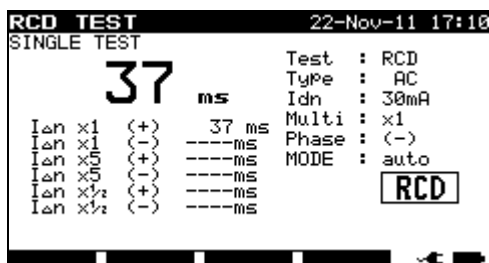

Step 1

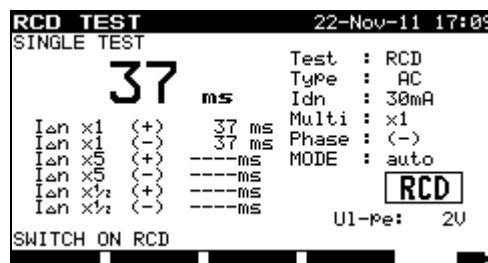

Step 2

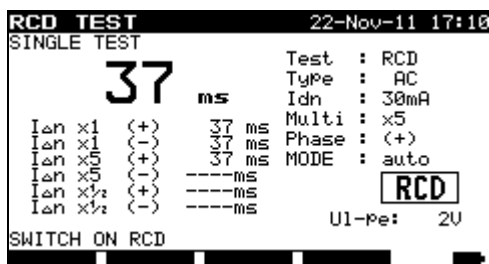

Step 3

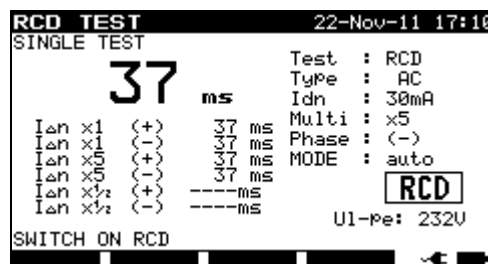

Step 4

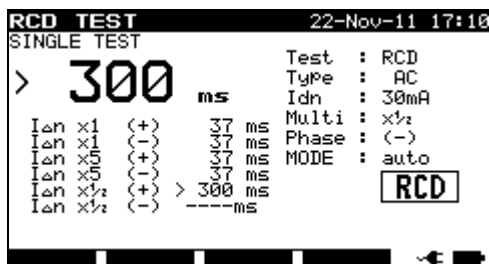

Step 5 and

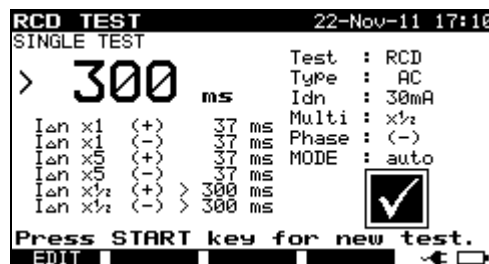

Step 6

Individual steps in RCD autotest

The test passes if tested RCD:

- Does not trip out at  $\frac{1}{2} \times I_{\Delta N}$  tests, and
- Trips inside predefined time limits at  $I_{\Delta N}$ , and  $5 \times I_{\Delta N}$  tests.

Displayed results:

Main result ..... last measured results

Sub-results ..... all results are displayed as sub-results

UI-pe ..... voltage UL-PE

**Notes:**

- Consider any displayed warning before starting measurement!
- For DUTs with integrated RCD the housing must be opened to access the RCD's L output terminal (this should only be performed by a competent engineer).
- Mains voltage is applied to the RCD under test. Do not touch the equipment under test or the test leads during the test!
- Testing B-type (P)RCD can only be performed on hardware release 2.0 and up and firmware release 1.24 and up.

**5.2.11 Functional test**

The DUT's power consumption is measured in this test. The apparent power is useful indication for proper operation of the DUT.

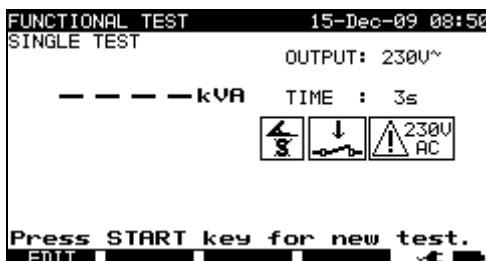

Functional test menu

**Test parameters for the Functional test**

OUTPUT	System voltage [230 V]
TIME	<b>Measuring time</b> [2 s, 3 s, 5 s, 10 s, 30 s, 60 s, 120 s, 180 s, none]

**Circuit for the functional test**

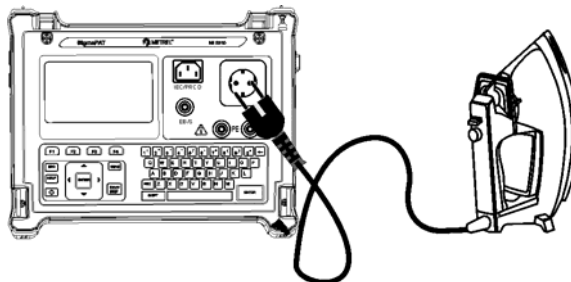

*Functional test*

**Functional test procedure**

- Select the **Functional test** function.
- Set measuring **time**.
- Connect** tested DUT to the instrument (see figure above).
- Press the **START** key for measurement.

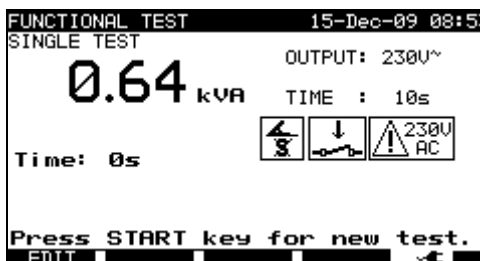

*Example of apparent power measurement result*

Displayed result:

Main result ..... apparent power

**Notes:**

- During the test, a mains voltage is connected to the DUT. If DUT contains moving parts, make sure that it is safely mounted or protected to prevent possible danger to the operator or damage to the DUT or surrounding environment!
- Consider any displayed warning before starting measurement!

## 5.3 Measurements – Single tests for welding machines

### Note:

- For testing welding machines the 3-phase operation mode must be enabled and the SigmaGT must be connected to a METREL 3-Phase adapter (A1322 or A1422). Refer to 3-phase AktivGT/Machine adapter (A1322/A1422) user manual for detailed information.

### 5.3.1 Continuity of the protective circuit

This test ensures that the connections between the protective conductor terminal in the mains plug of the DUT and earthed accessible conductive parts of the DUT (metal housing) are satisfactory and of sufficiently low resistance.

The instrument measures:

- the resistance between mains test socket's PE terminal / PE terminal (only if test current of 200 mA is set) and EB/S terminal.
- the resistance between mains test socket's PE terminal on 3-phase adapter and EB/S terminal on SigmaGT.

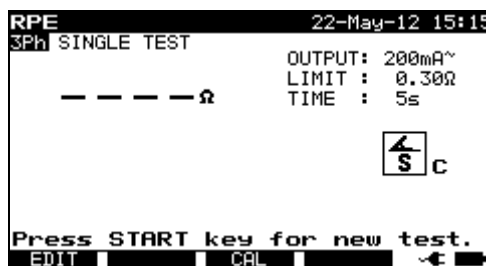

*Continuity menu*

### Test parameters for continuity measurement

OUTPUT	<b>Test current</b> [200 mA, 10 A, 25 A]
LIMIT	<b>Maximum resistance</b> [0.1 Ω ÷ 0.9 Ω, 1 Ω]
TIME	<b>Measuring time</b> [2 s, 3 s, 5 s, 10 s, 30 s]

### Test circuit and measurement procedure for continuity measurement

- 📖 For more information refer to chapter **Measurements according to IEC/ EN 60974-4**, paragraph **Continuity of the protective circuit** in 3-phase adapter user manual.

**Result screens:**

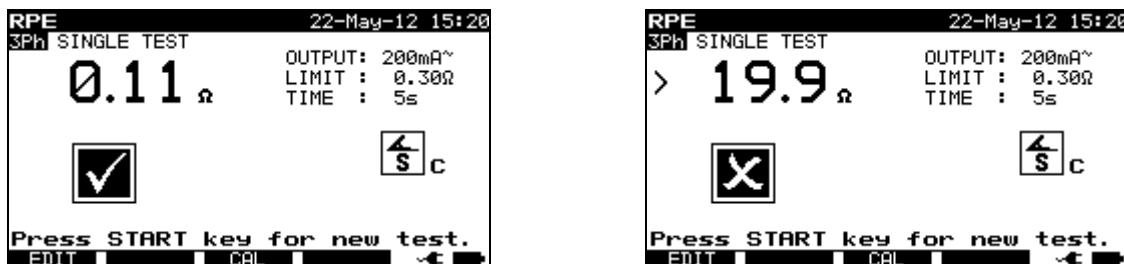

*Examples of continuity measurement results*

Displayed results:

Main result ..... resistance

**Note:**

- Consider displayed warnings before starting measurement!
- For compensation of test leads Description in Chapter 5.2.1.1 *Compensation of test leads resistance* can be used as reference.

**5.3.2 Insulation resistance (supply circuit to protective circuit)**

The insulation resistance test checks the resistance between the primary supply circuit and the protective circuit (protective earth) of the welding machine.

The instrument measures the insulation resistance between:

- mains test socket's live terminals and mains test socket's PE terminal on 3-phase adapter (A1422).

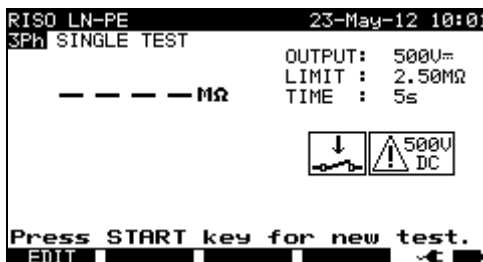

*Insulation LN-PE menu*

**Test parameters for insulation resistance LN-PE measurement**

OUTPUT	Test voltage [500 V]
LIMIT	Minimum resistance [2.50 MΩ, 5.00 MΩ, 10.0 MΩ, none]
TIME	Measuring time [2 s, 3 s, 5 s, 10 s, 30 s, 60 s, 120 s, 180 s, none]

**Test circuit and measurement procedure for insulation resistance LN-PE measurement**

For more information refer to chapter **Measurements according to IEC/ EN 60974-4**, paragraph **Insulation resistance (supply circuit to protective circuit)** in 3-phase adapter user manual.

**Result screens:**

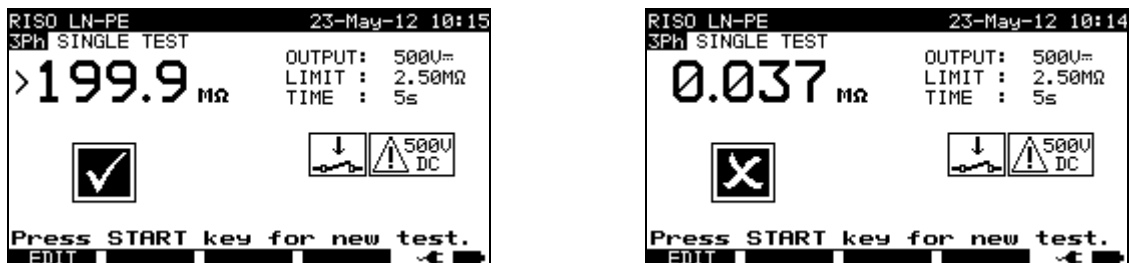

*Examples of Insulation LN-PE measurement results*

Displayed results:

Main result ..... Insulation resistance LN-PE

**Note:**

- Consider displayed warnings before starting measurement!

**5.3.3 Insulation resistance (welding circuit to protective circuit)**

The insulation resistance test checks the resistance between the welding circuit (outputs) and the protective circuit (protective earth) of the welding machine.

The instrument measures the insulation resistance between:

- mains test socket's PE terminal and W1/ W2 terminals on 3-phase adapter (A1422).

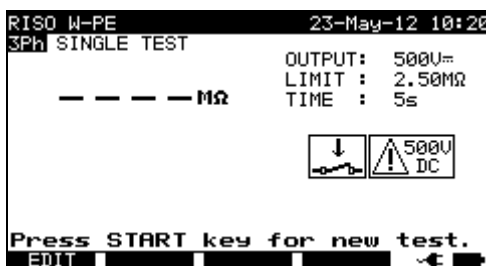

*Insulation W-PE menu*

**Test parameters for insulation resistance W-PE measurement**

OUTPUT	<b>Test voltage</b> [500 V]
LIMIT	<b>Minimum resistance</b> [2.50 MΩ, 5.00 MΩ, 10.0 MΩ, none]
TIME	<b>Measuring time</b> [2 s, 3 s, 5 s, 10 s, 30 s, 60 s, 120 s, 180 s, none]

**Test circuit and measurement procedure for insulation resistance W-PE measurement**

For more information refer to chapter **Measurements according to IEC/ EN 60974-4**, paragraph **Insulation resistance (welding circuit to protective circuit)** in 3-phase adapter user manual.

**Result screens:**

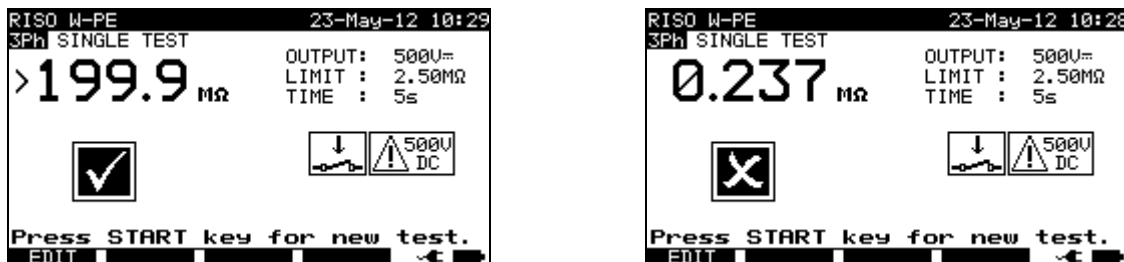

*Examples of Insulation W-PE measurement results*

Displayed results:

Main result ..... Insulation resistance W-PE

**Note:**

- Consider displayed warnings before starting measurement!

**5.3.4 Insulation resistance (supply circuit to welding circuit)**

The insulation resistance test checks the resistance between primary supply circuit and the welding circuit (outputs) of the welding machine.

The instrument measures the insulation resistance between:

- mains test socket's live terminals and W1/ W2 terminals on 3-phase adapter (A1422).

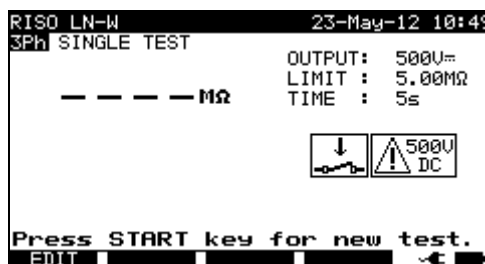

*Insulation LN-W menu*

**Test parameters for insulation resistance LN-W measurement**

OUTPUT	<b>Test voltage</b> [500 V]
LIMIT	<b>Minimum resistance</b> [5.00 MΩ, 10.0 MΩ, none]
TIME	<b>Measuring time</b> [2 s, 3 s, 5 s, 10 s, 30 s, 60 s, 120 s, 180 s, none]

**Test circuit and measurement procedure for insulation resistance LN-W measurement**



For more information refer to chapter **Measurements according to IEC/ EN 60974-4**, paragraph **Insulation resistance (supply circuit to welding circuit)** in 3-phase adapter user manual.

**Result screens:**

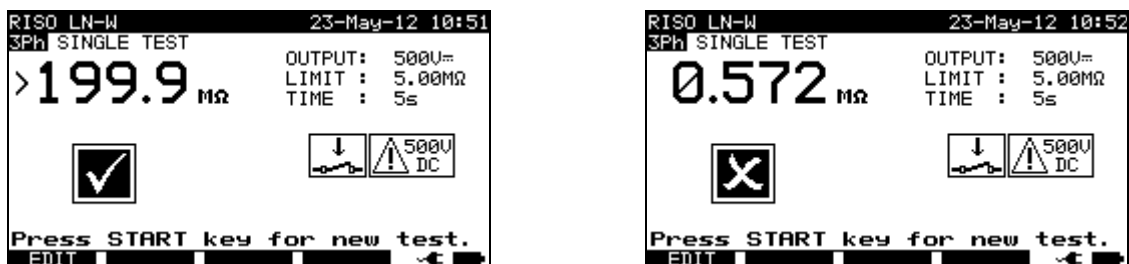

*Examples of Insulation LN-W measurement results*

Displayed results:

Main result ..... Insulation resistance LN-W

**Note:**

- Consider displayed warnings before starting measurement!

**5.3.5 Insulation resistance (supply circuit of class II equipment to accessible surfaces)**

The insulation resistance test checks the resistance between primary supply circuit and the isolated accessible conductive parts of the welding machine.

The instrument measures the insulation resistance between:

- mains test socket's live terminals on 3-phase adapter (A1422) and the EB/S terminal on SigmaGT.

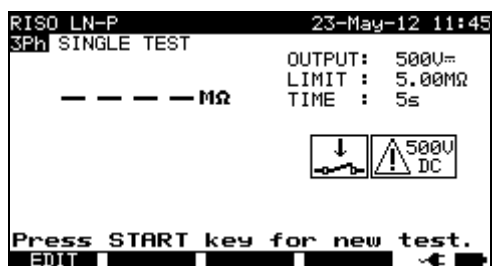

*Insulation LN-P menu*

**Test parameters for insulation resistance LN-P measurement**

OUTPUT	Test voltage [500 V]
LIMIT	Minimum resistance [5.00 MΩ, 10.0 MΩ, none]
TIME	Measuring time [2 s, 3 s, 5 s, 10 s, 30 s, 60 s, 120 s, 180 s, none]

**Test circuit and measurement procedure for insulation resistance LN-P measurement**

For more information refer to chapter **Measurements according to IEC/ EN 60974-4**, paragraph **Insulation resistance (supply circuit of class II to accessible surfaces)** in 3-phase adapter user manual.

**Result screens:**

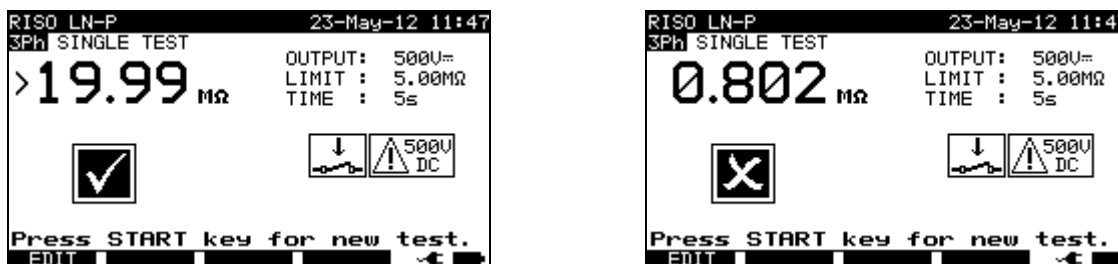

*Examples of Insulation LN-P measurement results*

Displayed results:

Main result ..... Insulation resistance LN-P

**Note:**

- Consider displayed warnings before starting measurement!

**5.3.6 Welding circuit leakage current**

The purpose of this test is to determine the sum of all leakage currents flowing from the welding outputs W1 or W2 to earth.

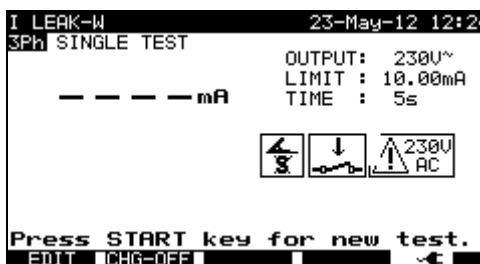

*Welding circuit leakage current menu*

**Test parameters for welding circuit current measurement**

OUTPUT	System voltage [230 V]
LIMIT	<b>Maximum current</b> [3.50 mA, 5.00 mA, 10.00 mA, none]
TIME	<b>Measuring time</b> [2 s, 3 s, 5 s, 10 s, 30 s, 60 s, 120 s, 180 s, none]

**Key (F2)**

CHG-OFF	Change between L-N on a single phase test socket of 3-phase adapter is disabled.
CHG-ON	Change between L-N on a single phase test socket of 3-phase adapter is enabled.

**Test circuit and measurement procedure for welding circuit leakage current measurement**

For more information refer to chapter **Measurements according to IEC/ EN 60974-4**, paragraph **Welding circuit leakage current** in 3-phase adapter user manual.

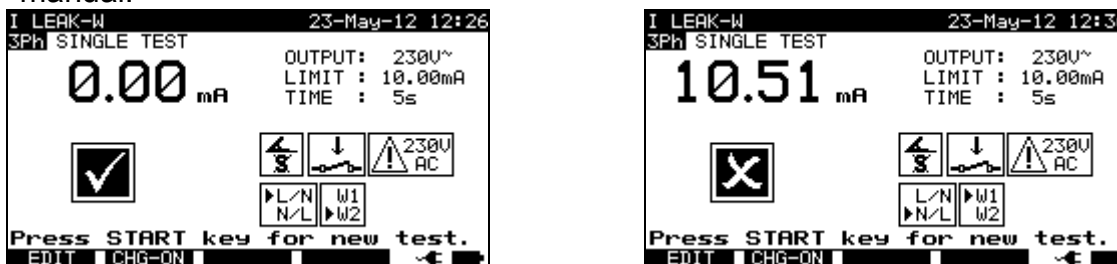

Examples of welding circuit leakage current measurement results

Displayed results:

Main result ..... welding circuit leakage current

**Notes:**

- During the test, a mains voltage is connected to the welding machine. Consider safety precautions.
- Consider any displayed warning before starting measurement!

**5.3.7 Primary leakage current**

The purpose of this test is to determine the sum of all leakage currents flowing from the primary circuit to earth. Because the differential measuring method for determining leakage current is used, the full and true DUT leakage current is always measured, even when parallel current paths to ground exist in the DUT.

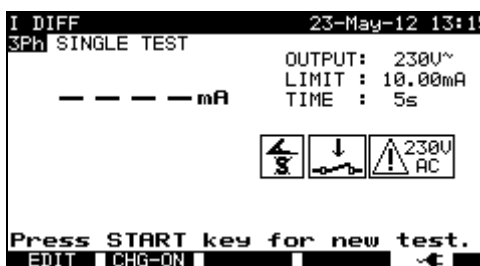

Primary leakage current menu

**Test parameters for primary leakage current measurement**

OUTPUT	System voltage [230 V]
LIMIT	<b>Maximum current</b> [3.50 mA, 5.00 mA, 10.00 mA, none]
TIME	<b>Measuring time</b> [2 s, 3 s, 5 s, 10 s, 30 s, 60 s, 120 s, 180 s, none]
<b>Key (F2)</b>	
CHG-OFF	Change between L-N on a single phase test socket of 3-phase adapter is disabled.
CHG-ON	Change between L-N on a single phase test socket of 3-phase adapter is enabled.

**Test circuit and measurement procedure for primary leakage current measurement**

For more information refer to chapter **Measurements according to IEC/ EN 60974-4**, paragraph **Primary leakage current** in 3-phase adapter user manual.

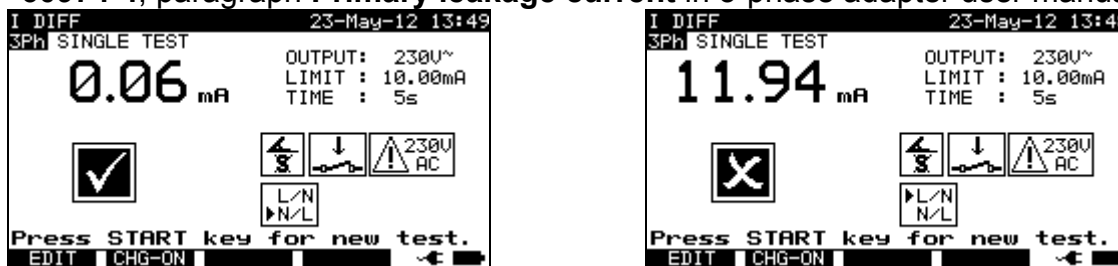

Examples of primary leakage current measurement results

Displayed results:

Main result ..... primary leakage current

**Notes:**

- During the test, a mains voltage is connected to the welding machine. Consider safety precautions.
- Consider any displayed warning before starting measurement!

**5.3.8 Touch leakage current**

Description in chapter 5.2.7 *Touch Leakage* can be used as reference.

**5.3.9 No load voltage**

The purpose of this test is to check that the voltage on the welding outputs doesn't exceed the safety limits.

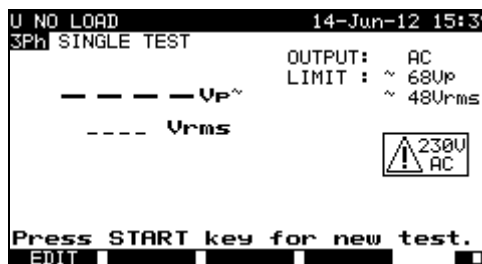

U no load menu

**Test parameters for U no load measurement**

VOLTAGE	[AC, DC]
LIMIT AC	<p><b>Maximum voltage:</b></p> <ul style="list-style-type: none"> <li>› 68 V peak and 48 V r.m.s.</li> <li>› 113 V peak and 80 V r.m.s.,</li> <li>› 141 V peak and 100 V r.m.s.,</li> <li>› none.</li> </ul>
LIMIT DC	<p><b>Maximum voltage:</b></p> <ul style="list-style-type: none"> <li>› 113 Vpeak,</li> </ul>

- 141 V<sub>peak</sub>,
- None.

### Test circuit and measurement procedure for U no load measurement

- 📖 For more information refer to chapter **Measurements according to IEC/ EN 60974-4**, paragraph **No load voltage** in 3-phase adapter user manual.

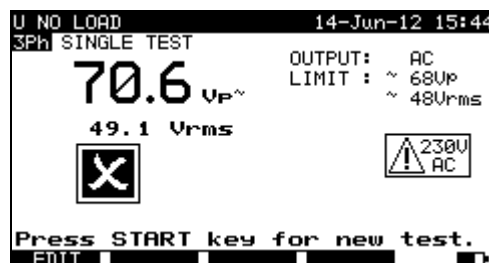
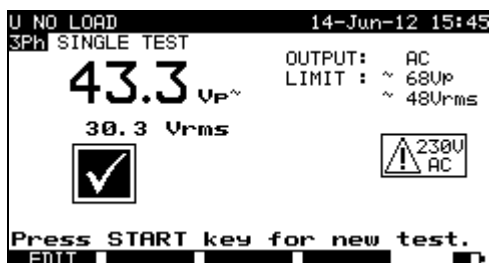

*Examples of No load voltage measurement results*

Displayed results:

Main result ..... no load a.c. or d.c. peak voltage

Sub-result.....no load r.m.s. voltage

#### Notes:

- During the test, a mains voltage is connected to the welding machine. Consider safety precautions.
- Consider any displayed warning before starting measurement!

### 5.3.10 Clamp current test

Description in chapter 5.2.9 *Clamp current test* can be used as reference.

### 5.3.11 Functional test

Descriptions in chapter 5.2.11 *Functional test* can be used as reference.

## **6 Autotest sequences**

Autotest is the fastest and easiest way to test DUTs. During the autotest preprogrammed measurements runs automatically in a sequential way. The complete autotest results can be stored together with their associated DUT name and all related information.

### **6.1 Autotest organizer– general menu**

Autotest organizer is a configuration tool for preparing and performing autotest sequence for devices covered by requirements of VDE 0701- 0702 and/or NEN 3140 standards\*.

The instrument selects the appropriate test sequence and parameters on base of entered DUT data (class, accessible conductive parts, nominal power etc).

The test sequence is built up according to the flowchart below. In addition tests for RCDs can be added to the sequence.

\* Option on request.

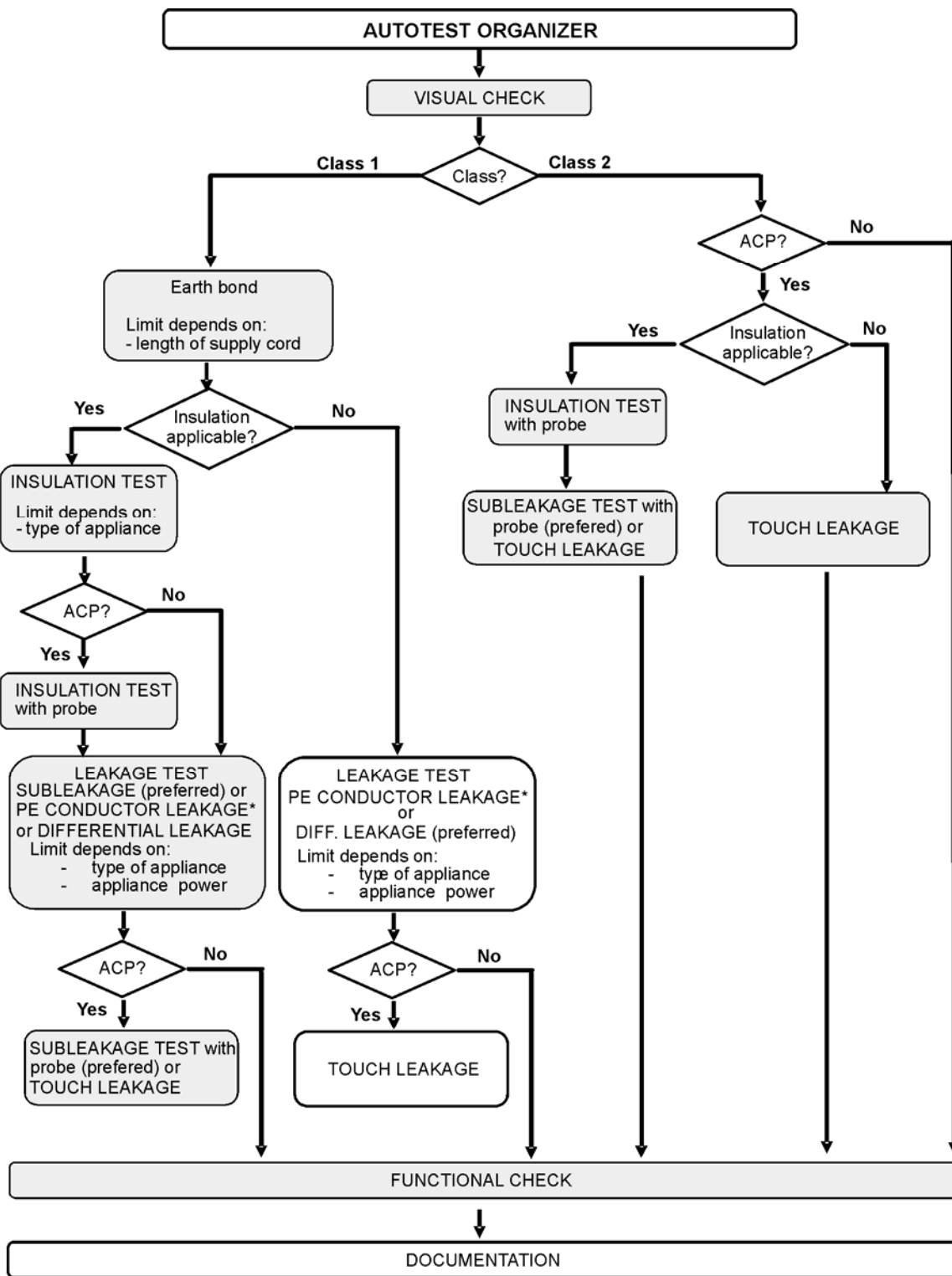

ACP: accessible conductive part, not earthed

With the autotest organizer any test sequence compatible with applied standard can be created. The sequences cover virtually any maintenance or periodic test, regardless of DUT type, safety class, supply cord length, fuse type, etc. All limits and tests comply with the currently valid standards and regulations. In case of any changes, a firmware upgrade will be available.

### 6.1.1 Autotest organizer operation

Select Autotest Organizer in main menu.

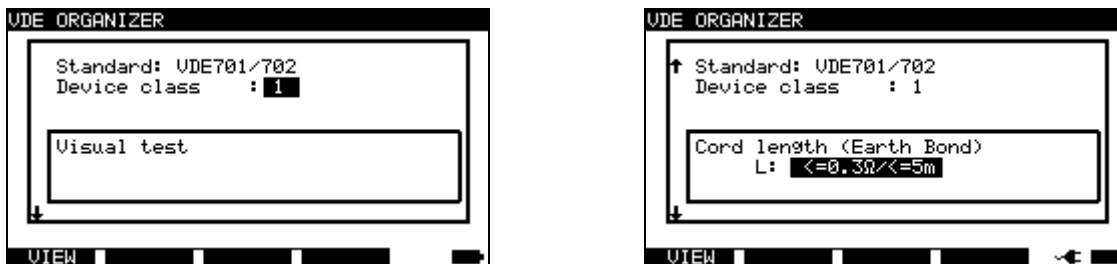

Examples of Autotest organizer screen

Keys:

- ▲ / ▼ Select organizer item.
- ◀ / ▶ Set parameter in selected (highlighted) item.
- ESC Returns to previous menu.
- VIEW (F1) Enters View (test sequence) menu.
- START Starts automatic sequence as currently set in autotest organizer. Refer to chapter 6.5 *Performing autotest sequences* for more information.

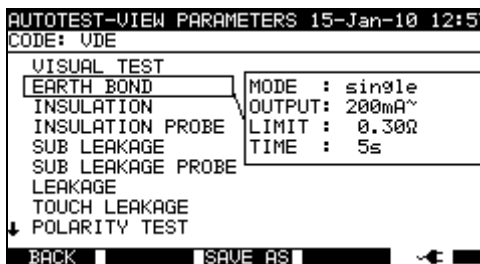

Autotest organizer view menu

In the View menu the parameters of the selected measurement can be viewed.

Keys in View menu:

▲ / ▼	Select test to be viewed.
START	Starts automatic sequence as currently set in autotest organizer. Refer to chapter 7.5 <i>Performing autotest sequences</i> for more information.
SAVE AS (F3)	Opens dialog for saving currently set sequence as a custom autotest.
BACK (F1)	Returns to mains autotest organizer menu.
ESC	Returns to previous menu.



## 6.1.2 Example of creating a test sequence with autotest organizer

A periodic test of an iron will be performed.

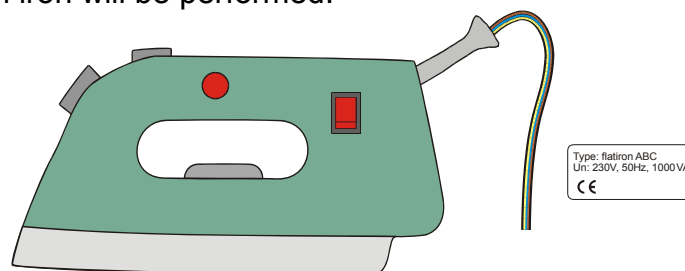

The iron can be classified as followed:

- For a periodic testing, e.g. the VDE0701-0702 test is relevant.
- The iron can be classified as a Class I DUT with isolated metal part and short supply cord.

Example of test sequence configuration:

	Displayed item	Activity
1	Standard: VDE 0701-0702	Information that a test acc. to VDE 0701-0702 (see note) will be set. <b>Note:</b> Option on request.
2	DUT class: <b>1</b>	Selection of DUT safety class: - Select Class I.
3	Visual test	Information that visual test will be included in the VDE / Class I procedure.
4	Accessible conductive parts? <b>YES</b>	Question if there is an isolated conductive part on the DUT: - Confirm with yes.
5	Cord length (Earth bond) L: <b>&lt; 0.3 Ω / &lt;= 5 m</b>	Selection of Earth bond limit value on base of known supply cable length: - Select appropriate length.
6	Insulation test applicable? <b>YES</b>	Question if insulation test is applicable: - Confirm with yes. Insulation and substitute leakage measurements will be included in the test sequence with this confirmation.
7	Insulation test <b>Heating elements L: &gt;0.3 MΩ</b>	Classification of DUT: - Classify the iron as a standard DUT.
8	Insulation test Accessible cond. Parts L: >2.0 MΩ	Information that insulation resistance measurement of Class 2 parts will be included in the (VDE / Class I / with isolated accessible conductive parts) test procedure.
9	Leakage test method: <b>Leakage</b>	Selection of leakage current test method: - Select substitute leakage measurement.
10	Limit / Device type <b>General device L &lt; 3.5 mA</b>	Classify the iron as an standard DUT with power <3.5 kW.
11	Touch leakage method: Substitute leakage Limit < 0.5 mA	Information that substitute leakage current measurement class 2 parts will be included in the (VDE / Class I / with isolated accessible conductive parts) test procedure.

The following parameters can be viewed in general for all measurements / tests:

- › Measurement mode,
- › Output test voltage or current (except in visual test and TRMS current measurement),
- › Pass level (except in visual test),
- › Measurement duration (except in visual test).

## 6.2 Custom autotests

In autotest custom menu setting and editing user-defined autotest procedures is allowed. Two sets (one for portable appliances and one for welding machines) of up to 50 custom autotest sequences can be pre-programmed in this autotest mode.

The most often used autotest sequences are added to the list by default.

The sequences can be also uploaded from the PC software PATLink PRO. Refer to chapter **7.5 Upload test data** for more information.

The pre-programmed sequences can be restored to default settings by selecting *Original settings* in **Setup** menu.

Select Custom Autotest in PAT testing main menu.



Custom autotest menu  
– appliances



Custom autotest menu  
– welding machines

Keys:

▼ / ▲	Selects the custom autotest.
VIEW (F1)	Opens View menu for viewing details of selected test sequence
DELETE (F3)	Removes selected test, see chapter <b>6.2.2 Deleting an existing custom test sequence</b> .
APPL. / WELDING (F4)	Switches between the two sets of custom autotests (if applicable).
START	Starts the selected autotest. See chapter <b>6.5 Performing autotest sequences</b> .
ESC	Returns to Main menu.

**Notes:**

- For testing welding machines the 3-phase operation mode must be enabled and the SigmaGT must be connected to a METREL 3-phase adapter (A1422). See A 1322 / A1422 user manual for more information.
- If more than 50 autotests are saved, »Out of memory« message is displayed.

- When active polarity test is enabled in autotest sequence then mains supply voltage is applied on test socket during earth bond test (if selected in autotest sequence).

### 6.2.1 Viewing, modifying and saving an custom autotest

An existing custom autotest sequence can be viewed, modified and saved. These functionalities are available in the *Custom autotest view menu*.

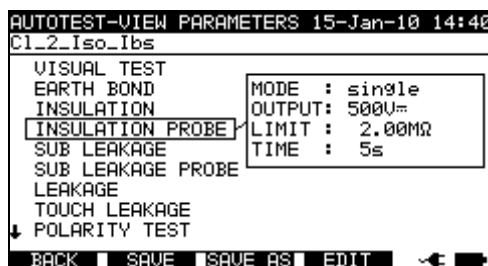

View setup of selected custom autotest

Keys in custom autotest sequence view mode:

▲ / ▼	Select test function in the sequence.
<b>SAVE (F2)</b>	Stores autotest sequence under the same name. See chapter <b>6.2.1.2 Saving autotest sequences</b> .
<b>SAVE AS (F3)</b>	Stores autotest sequence under a new name. See chapter <b>6.2.1.2 Saving autotest sequences</b> .
<b>EDIT (F4)</b>	Opens menu for modifying parameters of selected test function. See chapter <b>6.2.1.1 Modification of an autotest sequence</b> .
<b>START</b>	Starts running the selected autotest. See chapters <b>6.5 Performing autotest sequences - appliances</b> or <b>6.6 Performing autotest sequences – welding machines</b> .
<b>BACK (F1)</b> <b>ESC</b>	Returns back to custom autotest menu.

#### 6.2.1.1 Modification of an autotest sequence

Each test function has at least one parameter to set / reset or adjust.

##### Common parameters:

<b>MODE</b>	Defines appearance of selected function, see table below.
If MODE not disabled	
<b>OUTPUT</b>	Amplitude of measuring quantity, see particular test functions.
<b>LIMIT</b>	Limit value of measured item, intended for PASS/FAIL decision.
<b>TIME</b>	Required test period.

Measurement mode options:

Mode	Option	Note
<i>Disable</i>	The selected measurement is skipped.	
<i>Single</i>	One measurement will be performed	

	during the autosequence.	
<i>Continuous</i>	Up to 10 repetitive measurements can be performed.	Worst result is displayed on the top of the list.
<i>Enable</i>	Test can be performed.	Only visual test and polarity test

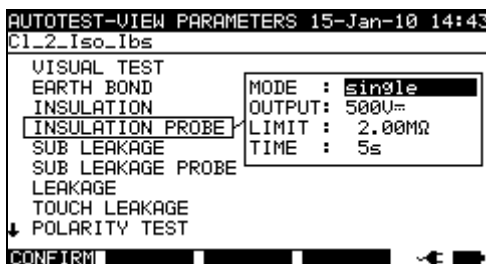

Modification parameters of selected test function

Keys:

▼ / ▲	Select the parameter.
◀ / ▶	Change the value of selected parameter (highlighted).
<b>CONFIRM</b> (F1)	Accepts modified function and returns to the view of selected test sequence.
<b>ESC</b>	Returns to the view of selected test sequence without changes.

### 6.2.1.2 Saving autotest sequences

There are two saving possibilities; they are defined in view menus of particular autotest option.

**SAVE** Stores autotest sequence in the place of selected autotest sequence, name can be modified.

**SAVE AS** Stores as new autotest sequence next to the last one, existing-base autotest sequence keeps unchanged.

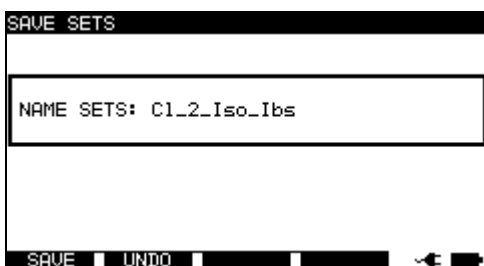

Save option



Save as option

Autotest custom Save menus

Keys:

◀ / ▶	Select character in line.
Alphanumeric	Enters character.
<b>SHIFT+</b> Alphanumeric	Enters small letter or special character.
←	Deletes character left to cursor.

<b>SAVE (F1)</b>	Confirms saving custom autotest sequence under entered name.
<b>UNDO (F2)</b>	Discards modifications and recover original entry.
<b>ESC</b>	Returns back to custom autotest menu.

## 6.2.2 Deleting an existing custom test sequence



*Delete selected custom autotest sequence*

Keys:

<b>Y/ N</b>	Confirms or rejects deleting of selected custom autotest sequence.
Any other key	Return back to custom autotest menu without changes.

**Note:**

- First custom autotest from the list cannot be deleted!

## 6.3 Project autotests

The **Project autotests** is an unique tool that dramatically simplifies and speeds up repeated (periodic) testing of DUTs.

The main idea is to re-use known stored data (either in instrument or on a PC) of the tested DUT. The following data can be recalled from the instrument's memory and re-used:

### Test sequence

If the sequence has not changed (this is usually the situation) the user does not need to care about setting the right test sequence and parameters.

### DUT data

ID number, names, descriptions, addresses, comments are not needed to be re-entered again. Old data are offered by default.

### Old test results

New Project Autotest test results can be compared with previous results. The instrument automatically calculates the trends for each measurement.

**Note:**

- If the test results are close to the limit they should be compared with old test results. If the trends are deteriorating, the safety of the DUT and the time between tests should be reassessed. If the results stay stable the DUT can generally be treated as safe.

Old test results can be uploaded from a PC back to the instrument. This brings further advantages:

- Old test results are not occupying the instrument's memory and can be temporarily uploaded only for the purpose of re-testing,
- Test results and DUT data can be moved / shared among different test instruments,
- DUT data can be pre-entered on the computer and then sent to the instrument.

### 6.3.1 Selecting a project autotest

The first step when performing project autotests is to recall the appropriate stored DUT data from the instruments memory. The procedure is similar as if test results are to be recalled from the instrument's memory.



*Project autotests main menu*

When searching for stored autotest results the following filters can be used to narrow the hits:

- Device number,
- User,
- Test site,
- Location,
- Date from and date to.

Keys:

▼ / ▲	Select filter line.
◀ / ▶, Alphanumeric	Edit selected filter.
<b>FIND</b> (F1)	Starts search after filters are set correctly.
<b>UNDO</b> (F2)	Undo latest change.
<b>TYPE</b> (F3)	Selects parameter line type.
<b>ESC</b>	Returns to Main menu.

**Notes:**

- To change the selected parameter line type, press the TYPE (F3) key and the »parameter type« will become highlighted (e.g. DUT). The keys ◀ and ▶ can then be used to change the parameter type and by pressing ENTER key the choice can be confirmed. Once the parameter types have been set up, the data required to filter the files can be inserted. Filter information can be inserted via the alphanumeric keypad or, in some filter fields such as user, can also be selected from a predefined list by pressing the LIST (F4) key. The DUT number field can also be read using a barcode reader.
- By placing a »\*« (shift + "2") in a particular field, tells the instrument not to search the associated filter field. When searching, the instrument will therefore ignore data in

this parameter and go on to find all the DUTs that conform to data placed in the other filter fields.

- To find all stored results, enter »\*« in the all fields (excluding DATE where the correct from and to dates must be entered).

If the search filters are set up correctly and the DUTs exist in the units memory, the **Project autotests result** menu will be displayed.

While recalling stored results, the instrument shows a bar graph and a ratio of files found compared to files stored in memory (e.g. 7/11 implies 7 results have been found to meet the filter criteria out of a potential 11 results stored in the flash memory).

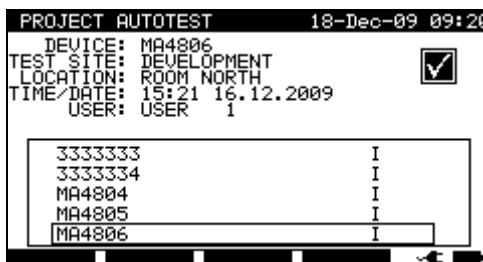

*Project autotest result menu*

Keys:

▼ / ▲	Select the DUT that should be retested.
<b>PgUp</b> (F1)	
<b>PgDown</b> (F2)	
<b>ENTER</b>	Recalls autotest project results for selected DUT.
<b>START</b>	Starts running new autotest for selected DUT, see 6.3.2 <i>Starting a project autotest</i>
<b>ESC</b>	Returns to Main menu.

**Note:**

- Barcode reader can also be applied for selecting the DUT, see chapter 6.4 *Working with barcode / RFID tag*.

### DUT tickers

Each DUT is marked with a ticker. The ticker appears at the right of the DUT number and helps to speed up finding DUTs to be retested.

The meaning of the tickers is as follows:

- PC The stored DUT data was uploaded from PC
- PC✓ The stored DUT data was uploaded from PC and has been retested
- I The stored DUT data was performed with the instrument and stored.
- I✓ The stored DUT data was performed with the instrument and stored and has been retested.

### Recalling autotest project results for selected DUT

By pressing ENTER key on an DUT, more information regarding the DUT results and data can be viewed.

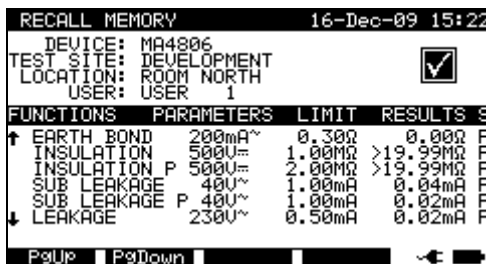

View results menu examples

Keys:

▼ / ▲	Scroll over stored results of particular functions for selected custom autotest sequence.
PgUp (F1)	
PgDown (F2)	
ESC	Returns to Main menu.

### 6.3.2 Starting a project autotest

Starting the project autotest will apply the sequence as is defined for selected device. Each test function that is not disabled is executed in prescribed order, see 6.5 *Performing autotest sequences – appliances* or 6.6 *Performing autotest sequences – welding machines*. After the prescribed testing is finished, the instrument offers some saving options.

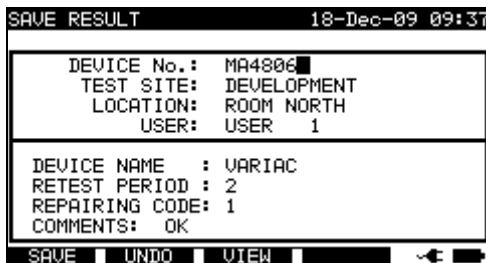

Saving options after retesting

Keys:

SAVE (F1)	Saves results, see 7.1 <i>Saving autotest results</i> .
VIEW (F3)	Opens menu for viewing and evaluating test results. See chapter 6.3.3 <i>Comparison of results (evaluation of result trends)</i> .
UNDO (F2)	Returns to Project autotest menu.
ESC	

Exactly the same DUT data (except time and user) will be offered to store in the selected Project autotest.

When a new autotest is saved, it will get an »I« ticker. The original autotest will get a »I✓« or »PC✓« ticker when the DUT is retested through the project autotest.



### 6.3.3 Comparison of results (evaluation of result trends)

Viewing results of retested DUT offers not only to check results as they are but also an additional option TREND is offered. Trend enables evaluation of critical safety parameters of the DUT.

FUNCTIONS	PARAMETERS	LIMIT	RESULTS
VISUAL			
EARTH BOND	200mA~	0.300	0.020
INSULATION	500V~	1.00MΩ	>19.99MΩ
INSULATION P	500V~	2.00MΩ	>19.99MΩ
SUB LEAKAGE	40V~	1.00mA	0.04mA
SUB LEAKAGE P	40V~	1.00mA	0.02mA

View Project autotest results menu

Keys:

▼ / ▲	
<b>PgUp</b> (F1)	Scroll over test results of particular functions.
<b>PgDown</b> (F2)	
<b>TREND</b> (F4)	Trend comparison of current results with stored.
<b>ESC</b>	Returns to Project autotest menu.

#### Evaluation of test results

FUNCTIONS	OLD	NEW	TREND
EARTH BOND	0.000	0.020	↓
INSULATION	>199.9MΩ	>199.9MΩ	○
INSULATION P	>199.9MΩ	>199.9MΩ	○
SUB LEAKAGE	0.04mA	0.04mA	○
SUB LEAKAGE P	0.02mA	0.02mA	↓
LEAKAGE	0.02mA	0.02mA	↑

Compare results menu example

Meaning of trend symbols:

- ↑ New result of particular test is better than last result.  
Examples: New insulation resistance result is higher than old result.  
New earth bond result is lower than old one.
- Difference between old and new result of particular test is so small that can be treated as the same.  
Example: New insulation resistance result stays at the same level as old result.
- ↓ New result of particular test is worse than last result.  
Examples: New insulation resistance result is lower than old result.

New earth bond result is higher than old one.

Keys:

▼ / ▲	Scroll over comparison results of particular functions.
<b>PgUp</b> (F1)	
<b>PgDown</b> (F2)	
<b>ESC</b>	Returns to Project autotest menu.

**Note:**

- Trend operates only before saving the new results of autotest procedure and with existing old results of the same autotest procedure in the instrument memory.

### 6.4 Working with barcode / QR code / RFID tag

In BARCODE / TAG menu operation with pre-defined test codes, barcodes, QR codes and RFID tags is supported:

- manual selection of pre-defined autotest shortcut codes;
- reading pre-defined autotest shortcut codes from barcode labels;
- reading pre-defined autotest shortcut codes from RFID tags;
- reading appliance ID numbers from barcode labels;
- reading appliance ID, name, Re-test date, and Location from RFID tags;
- reading pre-defined autotest codes and appliance ID numbers from barcode labels (double barcode format);
- reading and executing pre-defined autotest codes from QR codes using Bluetooth communication with Android application on mobile devices;
- reading appliance ID, name, Re-test date, Location and Test results from QR codes.

Refer to *Appendix B Barcode and QR code formats* for more information regarding barcode and QR code labels.

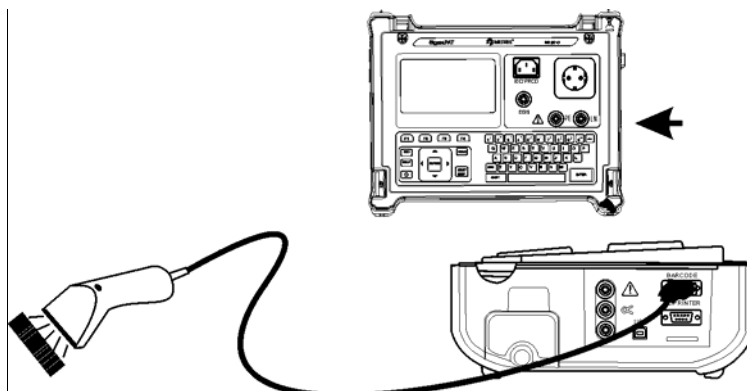

Connecting the barcode reader to the SigmaGT instrument

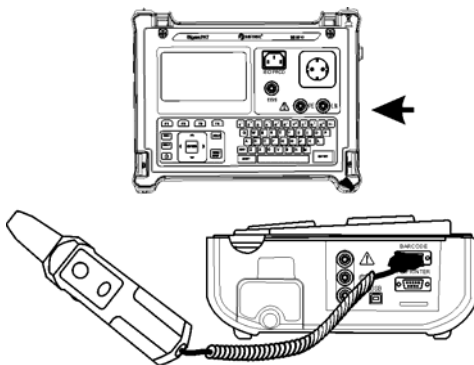

Connecting the RFID tag reader/writer to the SigmaGT instrument

After entering the BARCODE / TAG menu the following menu appears:

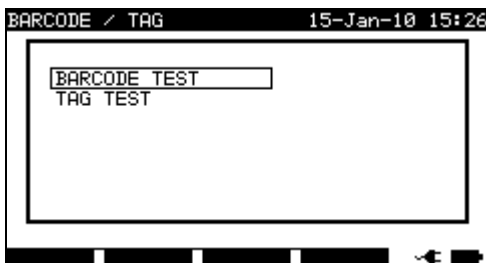

Barcode / RFID tag autotest menu

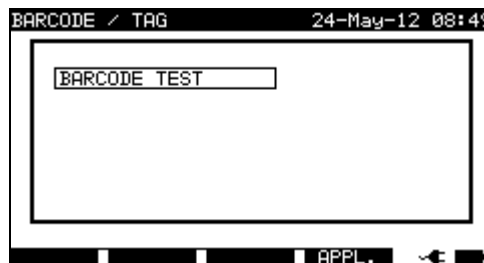

Barcode menu – welding machines

Keys:

▼ / ▲	Select the reader device.
<b>APPL. / WELDING</b> (F4)	Switches between operating mode for appliances and welding machines.
<b>ENTER</b>	Opens menu for selected device.
<b>ESC</b>	Returns to Main menu.

### 6.4.1 Working with RFID tags

With the bottom screen, the SigmaGT instrument is ready to accept RFID tag data.

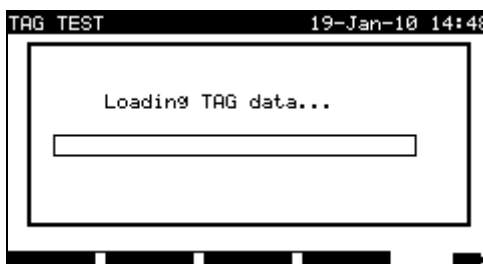

Waiting for RFID tag data

Key:

<b>ESC</b>	Returns to Barcode/tag menu.
------------	------------------------------

Once the data from RFID tag have been successfully received, the following menu is displayed:



*RFID tag menu*

Keys:

▼ / ▲	Select the option.
<b>ENTER</b>	Opens menu for selected option.
<b>ESC</b>	Returns to Barcode/tag menu.

If no test results were stored in RFID tag, the **View results** option won't be displayed.

The following actions can be performed:

- New reading from RFID tag,
- View autotest sequence,
- View autotest results,
- Start autotest sequence.

### Viewing autotest sequence from RFID tag

Select View autotest in TAG menu and press ENTER key to confirm. Refer to chapter **6.2.1 Viewing/modifying and saving of existing custom autotest**.

### Starting autotest sequence from RFID tag

Select **Start new autotest** in TAG menu and press ENTER key. Refer to chapter **6.5 Performing autotest sequences - appliances**.

### Viewing autotest results from RFID tag

Select **View results** in TAG menu and press ENTER key to confirm. Refer to chapter **7.2 Recalling results**.

### Sending an autotest sequence to RFID tag

From the **Autotest custom menu** press the SEND key. Selected autotest sequence is loaded to the RFID tag using RFID reader/writer.

See **RFID reader/writer user manual** for more information.

### Sending an autotest sequence/results to RFID tag

Autotest sequence/results can be sent to RFID TAG from the Save results or Recall memory menu. Press the SEND key. When sending data from Recall results menu

select TAG reader/writer option first and press ENTER key to confirm. Selected data from the instrument are loaded to the RFID tag using RFID reader/writer. See **RFID reader/writer user manual** for more information.

**Note:**

- Because of limited memory space of RFID tags, the following data are not stored in RFID tags:
  - DUT name,
  - Repairing code,
  - Comments.

## 6.4.2 Reading autotest code from barcode / QR code

In BARCODE/ TAG menu the instrument enables reading of test code and/ or device number from a barcode.

In combination with an Android mobile device the instrument enables reading test code, device ID number, device name, location and retest date from a QR-code.

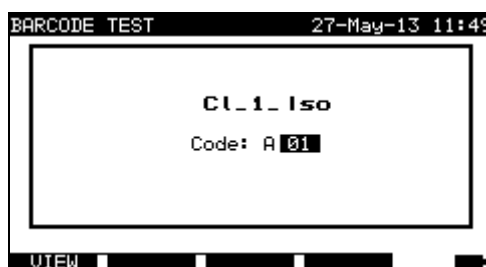

*Test code reading possibility*

A successful receive of the barcode / QR code data is confirmed by two short confirmation beeps.

## 6.4.3 Reading barcode for working with results

For working with stored results, a scanner can also be applied for DUT data entry. A successful receive of the barcode is confirmed by two short confirmation beeps.

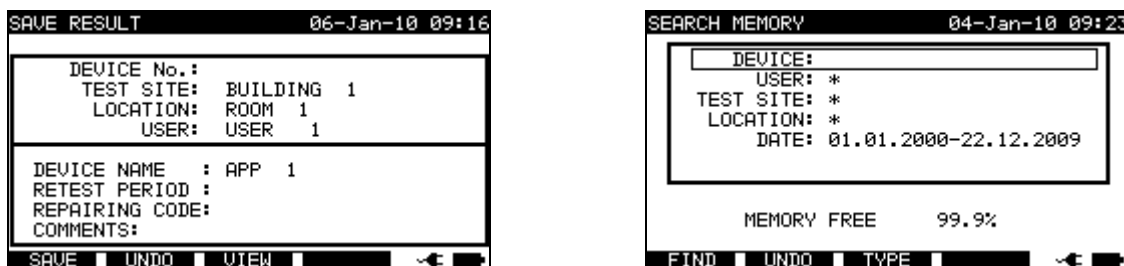

*Adding DUT number in save results / search results menu*

## 6.5 Performing autotest sequences – for appliances

An autotest can be started from any of the **Autotest** menus by following simple procedures:

- In **Autotest shortcut** menu, select the test sequence to be executed by code (see **6.1.1 Selecting the autotest shortcut sequence**).
- In **Autotest custom** menu, select the test sequence to be executed (see **6.2 Autotest custom**).
- In **Project autotest** menu, select the test sequence to be executed by device number (see **6.3.1 Selecting a project autotest**).

Press the START key to start the autotest sequence.

Note that autotest procedure can be concluded or with skipped particular functions in case that any of previous preceded function is skipped or get bad result. Reason is safety for operator and DUT.

### 6.5.1 Visual inspection

A thorough visual check must be carried out before each electrical safety test.

Following items should be checked:

- Inspection of DUT for sign of damage.
- Inspection of flexible supply cable for damage.
- Any signs of pollution, moisture, dirt that can jeopardize safety. Especially openings, air filters, protection covers and barriers must be checked!
- Are there signs of corrosion?
- Are there signs of overheating?
- Inscriptions and marking related to safety must be clearly readable.
- Installation of the DUT must be performed according to the user manuals.
- During visual inspection the measuring points for the electrical testing have to be determined too.

If the visual test passes, the instrument automatically proceeds with the next test in the sequence.

If the visual test fails the user must evaluate if it is safe to proceed with the measurements.

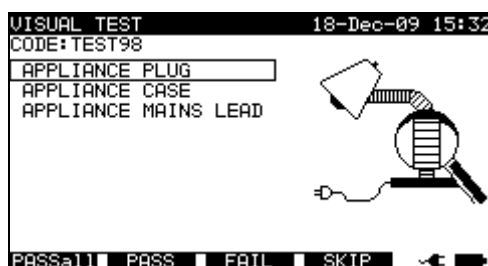

*Visual test menu*

Keys

- |                     |  |
|---------------------|--|
| <b>PASSa11</b> (F1) | Confirms that the complete visual inspection passed. |
| <b>PASS</b> (F2)    | Confirms that the visual inspection passed.          |
| <b>FAIL</b> (F3)    | Ends the autotest sequence.                          |
| <b>SKIP</b> (F4)    | Skips visual test.                                   |

## 6.5.2 Earth bond resistance measurement

Measurement is described in chapter **5.2.1 Earth bond resistance**.

If the earth bond test fails or was skipped other tests will not be carried out because of safety.

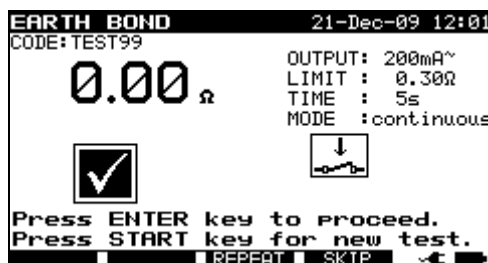

*Earth bond menu*

### Keys

#### START

Starts the earth bond resistance measurement.

Proceeds with the next earth bond resistance measurement (in continuous mode).

Proceeds to the next autotest sequence measurement (in single measurement mode only).

#### ENTER

Proceeds to the next autotest sequence measurement (in continuous measurement mode only).

#### REPEAT (F3)

Repeats the earth bond resistance measurement.

#### SKIP (F4)

Skips earth bond resistance measurement.

### Notes:

- Compensation of test leads resistance should be performed before doing autotests.
- When polarity test is enabled in autotest sequence then earth bond resistance is performed between IEC test connector (PE terminal) and test socket (PE terminal). If polarity test is disabled in autotest sequence, earth bond test is performed between EB/S test probe and test socket (PE terminal).

## 6.5.3 Insulation resistance measurement

Measurement is described in chapter **5.2.2 Insulation resistance**.

If the insulation test fails or was skipped other tests will not be carried out because of safety.



*Insulation resistance menu*

## Keys

<b>START</b>	Starts the insulation resistance measurement.
	Proceeds with the next insulation resistance measurement (in continuous mode).
	Proceeds to the next autotest sequence measurement (in single measurement mode only).
<b>ENTER</b>	Proceeds to the next autotest sequence measurement (in continuous measurement mode only).
<b>REPEAT (F3)</b>	Repeats the insulation resistance measurement.
<b>SKIP (F4)</b>	Skips insulation resistance measurement.

### 6.5.4 Insulation resistance – S probe measurement

Measurement is described in chapter **5.2.3 Insulation resistance – S probe**.

If this insulation test fails or was skipped other tests will not be carried out because of safety.



*Insulation resistance – S probe menu*

## Keys

<b>START</b>	Starts the Insulation resistance – S probe measurement.
	Proceeds with the next insulation resistance measurement (in continuous mode).
	Proceeds to the next autotest sequence measurement (in single measurement mode only).
<b>ENTER</b>	Proceeds to the next autotest sequence measurement (in continuous measurement mode only).
<b>REPEAT (F3)</b>	Repeats the insulation resistance – S probe measurement.
<b>SKIP (F4)</b>	Skips insulation resistance – S probe measurement.

### 6.5.5 Substitute leakage current measurement

Measurement is described in chapter **5.2.4 Substitute leakage current**.

If the substitute leakage test fails or was skipped other tests will not be carried out because of safety.





*Substitute leakage test menu*

Keys:

- START** Starts the substitute leakage current measurement.
- Proceeds with the next substitute leakage current measurement (in continuous measurement mode only).  
Proceeds to the next autotest sequence measurement (in single measurement mode only).
- ENTER** Proceeds to the next autotest sequence measurement (in continuous measurement mode only).
- REPEAT (F3)** Repeats the substitute leakage current measurement.
- SKIP (F4)** Skip substitute leakage current measurement.

### 6.5.6 Substitute leakage – S probe measurement

Measurement is described in chapter **5.2.5 Substitute leakage – S probe**.

If the substitute leakage test fails or was skipped other tests will not be carried out because of safety.



*Substitute leakage - S test menu*

Keys:

- START** Starts the Substitute leakage current – S probe measurement.
- Proceeds with the next substitute leakage current –S probe measurement (in continuous measurement mode only).  
Proceed to the next autotest sequence measurement (in single measurement mode only).
- ENTER** Proceeds to the next autotest sequence measurement (in continuous measurement mode only).
- REPEAT (F3)** Repeats the substitute leakage current – S probe measurement.
- SKIP (F4)** Skips substitute leakage current – S probe measurement.

## 6.5.7 Differential leakage current

Measurement is described in chapter **5.2.6 Differential leakage current**.

If the differential leakage test fails or was skipped other tests will not be carried out because of safety.



*Leakage current test menu*

Keys:

**START** Starts the leakage current measurement.

Proceeds with the next leakage current measurement (in continuous measurement mode only).

Proceed to the next autotest sequence measurement (in single measurement mode only).

**ENTER** Proceeds to the next autotest sequence measurement (in continuous measurement mode only).

**REPEAT (F3)** Repeats the leakage current measurement.

**SKIP (F4)** Skips leakage current measurement.

## 6.5.8 Touch leakage current measurement

Measurement is described in chapter **5.2.7 Touch leakage current**.

If the touch leakage test fails or was skipped other tests will not be carried out because of safety.



*Touch leakage test menu*

Keys:

**START** Starts the touch leakage current measurement.

Proceeds with the next touch leakage current measurement (in continuous measurement mode only).

Proceed to the next autotest sequence measurement (in single

	measurement mode only).
<b>ENTER</b>	Proceeds to the next autotest sequence measurement (in continuous measurement mode only).
<b>REPEAT (F3)</b>	Repeats the touch leakage current measurement.
<b>SKIP (F4)</b>	Skips touch leakage current measurement.

### 6.5.9 Polarity test

Measurement is described in chapter **5.2.8 Polarity test**.

If the polarity test fails or was skipped other tests will not be carried out because of safety.

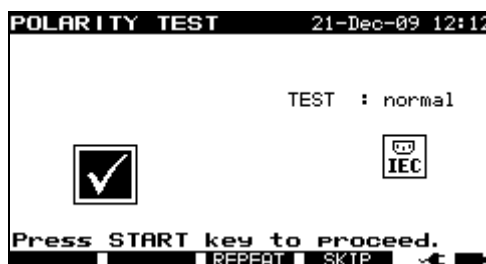

*Polarity test menu*

Keys:

<b>START</b>	Starts the polarity test. Proceed to the next autotest sequence measurement.
<b>REPEAT (F3)</b>	Repeats the polarity test.
<b>SKIP (F4)</b>	Skips polarity test.

### 6.5.10 TRMS current measurement using clamp current adapter

Measurement is described in chapter **5.2.9 Clamp current measurement**.

If the current clamp test fails or was skipped other tests will not be carried out because of safety.



*Clamp current menu*

Keys:

<b>START</b>	Starts the TRMS current measurement. Proceeds with the next TRMS current measurement (in continuous measurement mode only). Proceeds to the next autotest sequence measurement (in single measurement mode only).
--------------	---

<b>ENTER</b>	Proceeds to the next autotest sequence measurement (in continuous measurement mode only).
<b>REPEAT (F3)</b>	Repeats the TRMS current measurement.
<b>SKIP (F4)</b>	Skips TRMS current measurement.

### 6.5.11 RCD/PRCD test

Measurement is described in chapter **5.2.10 RCD/PRCD test**.

If the RCD test fails or was skipped other tests will not be carried out because of safety.



*RCD test menu*

Keys:

<b>START</b>	Starts the RCD test. Proceeds to the next autotest sequence measurement.
<b>REPEAT (F3)</b>	Repeats the RCD test.
<b>SKIP (F4)</b>	Skips the RCD test.

### 6.5.12 Functional test

The main objective of this test is to verify correct operation of the DUT.

Especially items relevant for safety should be checked:

- All main operating modes. Testing power during this check is useful.
- Mechanical operation (motors, rotating parts)
- Safety relevant functions (alarms, switches etc)

A PASS/ FAIL ticker can be committed manually.

The power measurement can be carried out optionally and is stored too. The Power measurement is described in chapter **5.2.11 Functional test**.



*Functional test menu*

Keys:

- START** Starts the POWER test (optional).  
Proceeds to the next autotest sequence measurement.
- PASS (F1)** Commits a manual ticker and ends autotest.
- FAIL (F2)** Commits a manual ticker and ends the autotest sequence.
- REPEAT (F3)** Repeats the Functional test.
- SKIP(F4)** Skips the Functional test.

## 6.6 Performing autotest sequences – for welding machines

### 6.6.1 Visual inspection

A thorough visual check must be carried out before each electrical safety test.

Following items should be checked:

- Inspection of DUT for sign of damage.
- Inspection of flexible supply cable for damage.
- Any signs of pollution, moisture, dirt that can jeopardize safety. Especially openings, air filters, protection covers and barriers must be checked!
- Are there signs of corrosion?
- Are there signs of overheating?
- Inscriptions and marking related to safety must be clearly readable.
- Installation of the DUT must be performed according to the user manuals.
- During visual inspection the measuring points for the electrical testing have to be determined too.

If the visual test passes, the instrument automatically proceeds with the next test in the sequence.

If the visual test fails the user must evaluate if it is safe to proceed with the measurements.

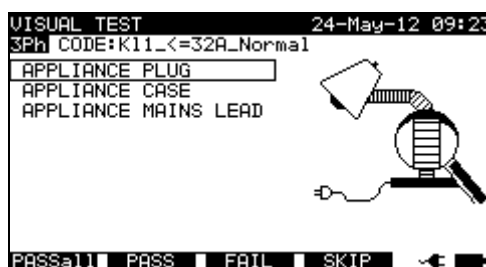

*Visual test menu*

Keys:

- |                     |  |
|---------------------|--|
| <b>PASSall</b> (F1) | Confirms that the complete visual inspection passed. |
| <b>PASS</b> (F2)    | Confirms that the visual inspection passed.          |
| <b>FAIL</b> (F3)    | Ends the autotest sequence.                          |
| <b>SKIP</b> (F4)    | Skips visual test.                                   |

### 6.6.2 Continuity of the protective circuit

Measurement is described in chapter 5.3.1 *Continuity of the protective circuit*.

If the Continuity test fails or was skipped other tests will not be carried out because of safety.



*Continuity autotest menu*

Keys:

**START**

Starts the continuity measurement.

Proceeds with the next continuity measurement (in continuous mode).

Proceeds to the next autotest sequence measurement (in single measurement mode only).

**ENTER**

Proceeds to the next autotest sequence measurement (in continuous measurement mode only).

**REPEAT (F3)**

Repeats the continuity measurement.

**SKIP (F4)**

Skips the continuity measurement.

**HELP**

Displays the continuity help screen.

**ESC**

Ends the autotest sequence.

**Note:**

- Compensation of test leads resistance should be performed before doing autotests.

### 6.6.3 Insulation resistance (supply circuit to protective circuit)

Measurement is described in chapter 5.3.2 *Insulation resistance (supply circuit to protective circuit)*. If this insulation test fails or was skipped other tests will not be carried out because of safety.



*Insulation LN - PE autotest menu*

Keys:

**START**

Starts the insulation resistance measurement.

Proceeds with the next insulation resistance measurement (in continuous mode).

Proceeds to the next autotest sequence measurement (in single

	measurement mode only).
<b>ENTER</b>	Proceeds to the next autotest sequence measurement (in continuous measurement mode only).
<b>REPEAT</b> (F3)	Repeats the insulation resistance measurement.
<b>SKIP</b> (F4)	Skips insulation resistance measurement.
<b>HELP</b>	Displays the insulation resistance test help screen.
<b>ESC</b>	Ends the autotest sequence.

#### 6.6.4 Insulation resistance (welding circuit to protective circuit)

Measurement is described in chapter 5.3.3 *Insulation resistance (welding circuit to protective circuit)*. If this insulation test fails or was skipped other tests will not be carried out because of safety.



*Insulation W - PE autotest menu*

Keys:

<b>START</b>	Starts the insulation resistance measurement. Proceeds with the next insulation resistance measurement (in continuous mode). Proceeds to the next autotest sequence measurement (in single measurement mode only).
<b>ENTER</b>	Proceeds to the next autotest sequence measurement (in continuous measurement mode only).
<b>REPEAT</b> (F3)	Repeats the insulation resistance measurement.
<b>SKIP</b> (F4)	Skips the insulation resistance measurement.
<b>HELP</b>	Displays the insulation resistance test help screens.
<b>ESC</b>	Ends the autotest sequence.

#### 6.6.5 Insulation resistance (supply circuit to welding circuit)

Measurement is described in chapter 5.3.4 *Insulation resistance (supply circuit to welding circuit)*. If the insulation test fails or was skipped other tests will not be carried out because of safety.





*Insulation LN - W autotest menu*

Keys:

**START**

Starts the insulation resistance measurement.  
 Proceeds with the next insulation resistance measurement (in continuous mode).  
 Proceeds to the next autotest sequence measurement (in single measurement mode only).

**ENTER**

Proceeds to the next autotest sequence measurement (in continuous measurement mode only).

**REPEAT (F3)**

Repeats the insulation resistance measurement.

**SKIP (F4)**

Skips insulation resistance measurement.

**HELP**

Displays the insulation resistance test help screen.

**ESC**

Ends the autotest sequence.

### 6.6.6 Insulation resistance (supply circuit of class II equipment to accessible surfaces)

Measurement is described in chapter 5.3.5 *Insulation resistance (supply circuit of class II equipment to accessible surfaces)*. If this insulation test fails or was skipped other tests will not be carried out because of safety.



*Insulation LN - P autotest menu*

Keys:

**START**

Starts the insulation resistance measurement.  
 Proceeds with the next insulation resistance measurement (in continuous mode).  
 Proceeds to the next autotest sequence measurement (in single measurement mode only).

**ENTER**

Proceeds to the next autotest sequence measurement (in continuous measurement mode only).

<b>REPEAT</b> (F3)	Repeats the insulation resistance measurement.
<b>SKIP</b> (F4)	Skips the insulation resistance measurement.
<b>HELP</b>	Displays the insulation resistance test help screens.
<b>ESC</b>	Ends the autotest sequence.

### 6.6.7 Welding circuit leakage current

Measurement is described in chapter 5.3.6 *Welding circuit leakage current*. If this leakage test fails or was skipped other tests will not be carried out because of safety.

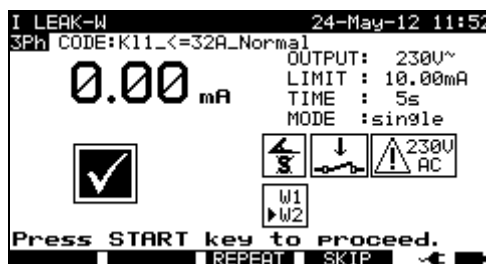

*Welding circuit leakage current autotest menu*

Keys:

<b>START</b>	Starts the leakage current measurement. Proceeds with the next leakage current measurement (in continuous mode). Proceeds to the next autotest sequence measurement (in single measurement mode only).
<b>ENTER</b>	Proceeds to the next autotest sequence measurement (in continuous measurement mode only).
<b>CHG ON</b> (F2)	The instrument automatically changes L and N polarity of connected welding equipment during the test (suitable for 1-phase equipment with schuko plug). Higher measured current will be considered.
<b>CHG OFF</b> (F2)	Disables the automatic change of polarity function.
<b>REPEAT</b> (F3)	Repeats the leakage current measurement.
<b>SKIP</b> (F4)	Skips the leakage current measurement.
<b>HELP</b>	Displays the leakage current test help screen.
<b>ESC</b>	Ends the autotest sequence.

### 6.6.8 Primary leakage current

Measurement is described in chapter 5.3.7 *Primary leakage current*. If this leakage test fails or was skipped other tests will not be carried out because of safety.



Primary leakage current autotest menu

Keys:

**START**

Starts the leakage current measurement.

Proceeds with the next leakage current measurement (in continuous mode).

Proceeds to the next autotest sequence measurement (in single measurement mode only).

**ENTER**

Proceeds to the next autotest sequence measurement (in continuous measurement mode only).

**CHG ON (F2)**

The instrument automatically changes L and N polarity of connected welding equipment during the test (suitable for 1-phase equipment with schuko plug). Higher measured current will be considered.

**CHG OFF (F2)**

Disables the automatic change of polarity function.

**REPEAT (F3)**

Repeats the leakage current measurement.

**SKIP (F4)**

Skips the leakage current measurement.

**HELP**

Displays the leakage current test help screen.

**ESC**

Ends the autotest sequence.

## 6.6.9 Touch leakage current

Measurement is described in chapter 5.2.7 *Touch leakage*. If this leakage test fails or was skipped other tests will not be carried out because of safety.

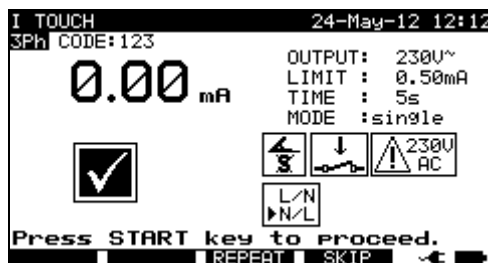

Touch leakage current autotest menu

Keys:

**START**

Starts the touch leakage current measurement.

Proceeds with the next touch leakage current measurement (in continuous mode).

	Proceeds to the next autotest sequence measurement (in single measurement mode only).
<b>CHG ON (F2)</b>	The instrument automatically changes L and N polarity of connected welding equipment during the test (suitable for 1-phase equipment with schuko plug). Higher measured current will be considered.
<b>CHG OFF (F2)</b>	Disables the automatic change of polarity function.
<b>ENTER</b>	Proceeds to the next autotest sequence measurement (in continuous measurement mode only).
<b>REPEAT (F3)</b>	Repeats the touch leakage current measurement.
<b>SKIP (F4)</b>	Skips the touch leakage current measurement.
<b>HELP</b>	Displays the touch leakage current test help screens.
<b>ESC</b>	Ends the autotest sequence.

### 6.6.10 No load voltage

Measurement is described in chapter 5.3.9 *No load voltage*. If this voltage test fails or was skipped other tests will not be carried out because of safety.



*No load voltage autotest menu*

Keys:

<b>AC/ DC (F2)</b>	The instrument sets appropriate limit values – depends on the welding machine's operating mode.
<b>START</b>	Starts the No load voltage measurement.
<b>ENTER</b>	Proceeds to the next autotest sequence measurement.
<b>REPEAT (F3)</b>	Repeats the No load voltage measurement.
<b>SKIP (F4)</b>	Skips the No load voltage measurement.
<b>HELP</b>	Displays the No load voltage test help screen.
<b>ESC</b>	Ends the autotest sequence.

### 6.6.11 TRMS current measurement using clamp current adapter

Refer to chapter 5.2.9 *Clamp current test* for reference.

### 6.6.12 Functional test

Refer to chapter 5.2.11 *Functional test* for reference.

## 7 Working with autotest results

After the autotest sequence is completed, measurement results can be:

- Saved to the flash memory of the instrument. Before that they can be viewed and edited. Refer to chapter **7.1 Saving autotest results** for more information.
- Send to PC or a test report can be printed out to serial printer. Refer to chapter **7.4 Downloading and printing results** for more information.
- DUT label can be printed out. Refer to chapter **7.4 Downloading and printing results** for more information.

### 7.1 Saving autotest results

After the autotest sequence is completed, **Save results** menu is displayed.

Following data can be added to the test results for saving:

- Device number and its name
- Test site and location,
- Retest period,
- Repairing code,
- Comments.

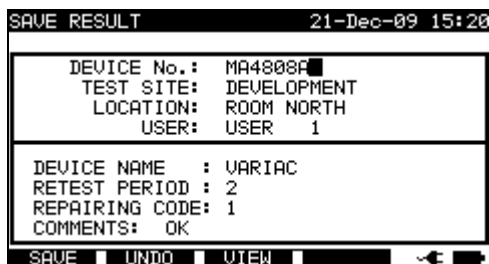

Save results menus

Keys:

▼ / ▲	Selects the item.
◀ / ▶, alphanumeric	Edits data
<b>SAVE</b> (F1)	Saves test results and returns to last autotest menu.
<b>UNDO</b> (F2)	Undo changes.
<b>VIEW</b> (F3)	Views test results, see 6.3.3 <i>Comparison of results</i>
<b>LIST</b> (F4)	Offers predefined names for selected field.
<b>ESC</b>	Returns to Main menu.

Entry fields for tested device data:

Field	Length*	Note
<b>DEVICE No.</b>	20ASN	Numeric code of device. It can also be entered via barcode reader scanning, see chapter 6.4 <i>Working with barcode / RFID tag</i> .
<b>Test site</b>	15ASN	Name of test site. Can also be selected from the list of 100 predefined names. 4.2.5.3 <i>Test sites submenu</i> .
<b>Location</b>	15ASN	Name of location. Can also be selected from the list of 100 predefined names. 4.2.5.4 <i>Locations submenu</i> .

<b>DEVICE NAME</b>	15ASN	Name of tested device. Can also be selected from the list of 100 predefined names, see <b>4.2.5.2 Devices submenu</b> .
<b>Retest period</b>	2N	Period to retest in months
<b>Repairing code</b>	20ASN	
<b>Comments</b>	25ASN	

\* Length is defined as:

N numerals (numeric characters),  
ASN alpha-numeric or special characters.

All parameters added to the autotest results have, in general, a possibility to be replicated or default set to blank when saving new autotest results. Device number can also be automatically incremented when new autotest sequence is finished.

For detailed description refer to chapter **4.2.8.6 Instrument settings**.

#### Notes:

- The date and time are automatically attached to the saved results.
- The autotest results cannot be stored if the Device no. field is empty.
- User** field cannot be edited (this must be selected from the *User/ Device data menu* of the instrument).

## 7.2 Recalling results

Select **Recall/delete/send memory** in **Main** menu by using  $\uparrow$  and  $\downarrow$  keys and press ENTER key to confirm. **Search memory** menu is displayed.

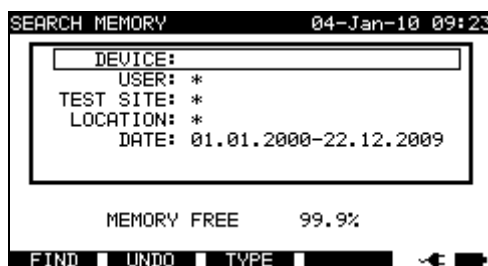

*Search memory menus*

When searching for stored results the following filters can be used to narrow the hits:

- DUT number
- Test site,
- Location,
- Date from and date to,
- User.

By using  $\uparrow$  and  $\downarrow$  cursor keys select the filter you want to edit.

Keys:

▼ / ▲	Selects parameter line.
◀ / ▶, Alphanumeric	Edits parameter line.
<b>FIND</b> (F1)	Starts search after filters are set correctly.
<b>UNDO</b> (F2)	Undo latest change.
<b>TYPE</b> (F3)	Selects parameter line type.
<b>ESC</b>	Returns to Main menu.

**Notes:**

- To change the selected parameter line type, press the F3 function key and the »parameter type« will become highlighted (e.g. DEVICE). The cursor keys ◀ and ▶ can then be used to change the parameter type and by pressing **ENTER** key the choice can be confirmed. Once the parameter types have been set up, the data required to filter the results can be inserted. Filter information can be inserted via the alphanumeric keypad or, in some filter fields such as user, can also be selected from a predefined list by pressing the F4 function key. The device number field can also be read using a barcode reader, see chapter 6.4 *Working with barcode / RFID tag*.
- By placing a »\*« (shift + "2") in a particular field, tells the instrument not to search the associated filter field. When searching, the instrument will therefore ignore data in this parameter and go on to find all the DUTs that conform to data placed in the other filter fields.
- To find all stored results, enter »\*« in the all fields (excluding DATE where the correct from and to dates must be entered).

When the search filters have been correctly set up, a search can be performed by pressing the **F1** function key. If the search filters are set up correctly and the DUTs exist in the units memory, the **Recall memory** menu will be displayed.

While recalling stored results, the instrument shows a bargraph and a ratio of files found compared to files stored in memory (e.g. 7/11 implies 7 results have been found to meet the filter criteria out of a potential 11 results stored in the flash memory).

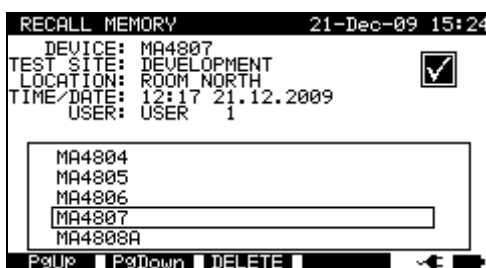

*Recall memory menu*

Once the DUTs have been found, the ▲ and ▼ cursor keys and **F1** and **F2** function keys can be used to scroll through the list of DUTs.

More information relating to a DUT can be viewed by pressing the **ENTER** key on the appropriate DUT. The information can be scrolled using the **F1** and **F2** function keys.

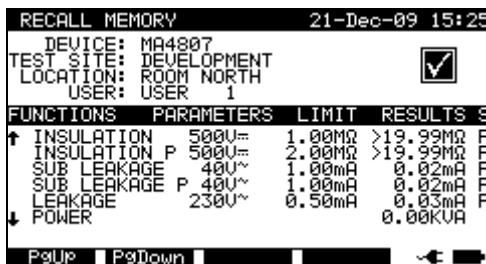

View results menu

Use the **ESC** key to return to **Recall memory** or **Search memory** menus. From the **Recall memory** menu stored data can be downloaded to a PC, printed out to a serial printer or deleted from the memory. Refer to chapters 7.4 *Downloading and printing results* and 7.3 *Deleting results*, respectively.

### 7.3 Deleting results

Stored autotest results can also be deleted from the memory.

Enter **Recall/delete/send memory** menu. Recall the result(s) you want to delete (Refer to chapter 7.2 *Recalling results* for detailed information on recalling results). In the **Recall memory** menu, press the **F3** function key. **Delete** menu will be displayed. In this menu the following functions can be performed.

- DELETE: Deletes the single file last highlighted when the **F3** function key was pressed,
- DELETE SELECTED: Deletes all the files found from searching the memory of the instrument,
- DELETE ALL: Clears all stored test data from the instrument.

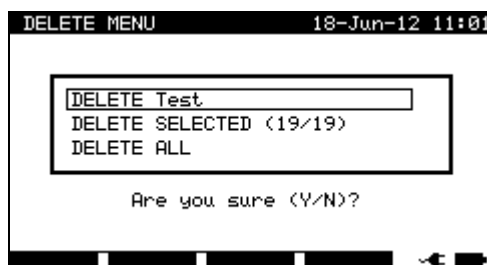
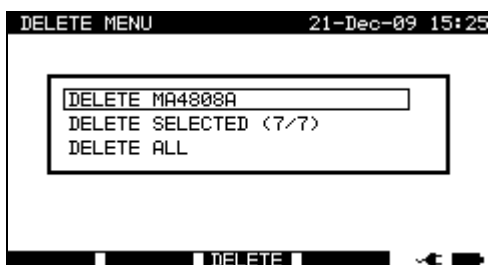

Delete results menu

Keys:

▼ / ▲	Selects deleting option.
<b>DELETE (F3)</b>	Enters the confirmation menu for deleting selected results.
<b>ESC</b>	Returns to Recall memory menu.

Confirm the delete activity by using **Y** key. After performing the selected option, instrument returns to **Recall memory** menu accepting the new memory state. If you don't want to delete the results, press the **N** key in **Delete** menu. Instrument returns to **Recall memory** menu without any changes.



## 7.4 Downloading and printing results

The selected results can be sent to following external devices

- Serial printer,
- Label printer,
- RFID tag

The information about selected external device is shown in the lower part of display. Refer to chapter 4.2.8.8 *Set Communication* for more information how to select external devices.

The selected results can be:

- printed as a result sheet,
- printed on label with QR code or barcode,
- written on a RFID tag

It is possible to send data to external device after:

- Autotest sequence is completed, or
- Recalling stored results from the instrument memory.

By pressing the **SEND** key in the **Save results** or **Recall memory** menus, **Send results** menu is available.

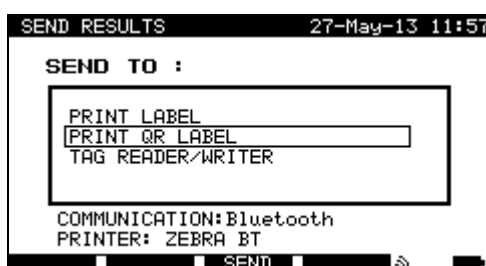

Send results (after autotest is completed)

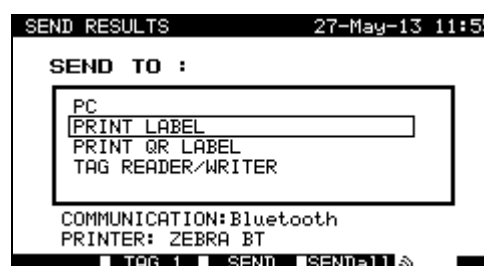

Send results (from recall menu)

Keys:

▼ / ▲	Selects activity.
<b>ESC</b>	Returns to recall memory or Save results menu.
<b>SEND</b> (F3)	Sends only selected result to the selected device.
<b>SENDall</b> (F4)	Sends filtered results (see 7.2 <i>Recalling results</i> ) to the selected device.
Send to barcode printer	
<b>TAG1</b> (F2) or	Generates one or two printed labels per stored result, e.g. for appliance only (TAG1) or for appliance plus its power supply cord (TAG2).
<b>TAG2</b> (F2)	

## 7.4.1 Send to serial printer

```

.....
METREL
Testing laboratory
Horjul, Slovenia
.....

DEVICE 11072010
TEST SITE METREL
LOCATION OFFICE 1
TIME/DATE 09:31 11-JUL-2008
USER TOMAZ
RESULT: PASS
-----
VISUAL PASS
EARTH BOND It: 10A~ Rlim: 0.10 Ohm
1. R = 0.03 Ohm PASS
INSULATION Ut: 500V Rlim: 1.00 MOhm
1. R = 178.9 MOhm PASS
LEAKAGE Ut: 230V~ Ilim: 0.75 mA
1. I = 0.23 mA PASS
POWER
1. P = 2.01KVA PASS
DEVICE NAME: APP 1
RETEST PERIOD : 11/07/2009
REPAIRING CODE: 021268505
COMMENTS: -
=====

END OF DATA

```

```

PRINT HEDER FOR MPL TESTING
2ND LINE
LAST HEADER LINE

      DEVICE                planchaMPL
TEST SITE                BUILDING  1
LOCATION                   ROOM    1
TIME/DATE                14:00 24-APR-2009
USER                     PJOTR
RESULT:                  PASS
-----
VISUAL                   PASS
EARTH BOND   It:200mA~ Rlim: 1.00 Ohm
1. R =                0.71 Ohm PASS
INSULATION   Ut: 500V Rlim: 0.30 MOhm
1. R =                >199.9 MOhm PASS
INSULATION S Ut: 500V Rlim: 1.00 MOh
1. R =                >19.9 MOhm PASS
SUB LEAKAGE  Ut:  40V~ Ilim: 4.50 mA
1. I =                0.02 mA PASS
SUB LEAKAGE  Ut:  40V~ Ilim: 0.50 mA
1. I =                0.01 mA PASS
DEVICE NAME   : plancha MPL 001
RETEST PERIOD : 24/04/2010
REPAIRING CODE: plancha
COMMENTS:VSE OK
=====

END OF DATA

```

*An example of data sent to serial printer*

### Notes:

- When working with serial printers, the baud rate is set by default to 9600 bps.
- Software transfer control uses XON (CTRL-Q) and XOFF (CTRL-S) characters.
- Hardware transfer control uses DTR line.

## 7.4.1 Send to barcode / QR code printer

Refer to chapter 4.2.8.6 *Instrument settings* and **Appendix B** for detailed information about barcode systems used when printing barcode or QR-code labels.

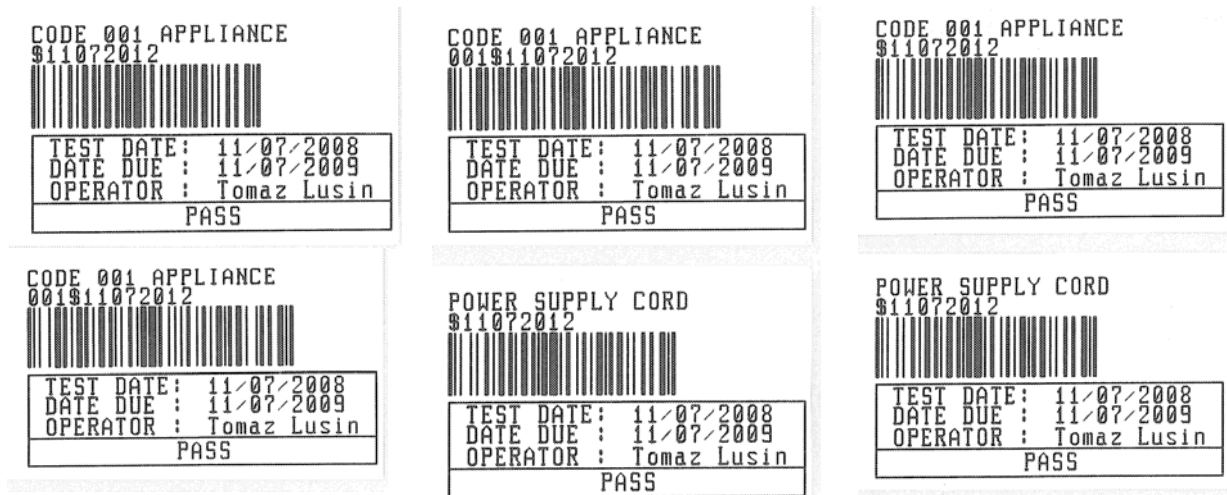

1 tag, barcode system: single (top label)  
1 tag, barcode system: double (bottom label)

2 tags, barcode system: double

2 tags, barcode system: single



QR code label

Examples of DUT labels

## 7.5 Data upload / download

Autotests and results from PC software can be uploaded to the instrument from the **Upload data / edit lists / check log** menu. Also the following items can be downloaded and edited or created with PC software and then uploaded onto the instrument:

- Users,
- DUTs,
- Test sites,
- Locations.



*Downloading / uploading test data menu*

During the data transfer from the PC to the instrument, the transfer status will be displayed.

Pressing ESC key instrument returns to **Main** menu.

For detailed information on data uploading / downloading refer to help menus of PC software PATLink PRO.

## 8 Maintenance

### 8.1 Periodic calibration

It is essential that all measuring instruments are regularly calibrated in order for the technical specification listed in this manual to be guaranteed. We recommend an annual calibration. The calibration should be done by an authorized technical person only.

### 8.2 Fuses

There are two fuses available from left side connector panel:

F1 = F2 = T 16 A / H 250 V (32 × 6.3 mm): intended for instrument protection.

If the instrument does not respond after connection to mains supply, disconnect the mains supply and accessories and then check these fuses. For position of fuses refer to chapter 2.2 *Connector panel*.

#### Warning!

- Switch off the instrument and disconnect all test accessories and mains cord before replacing the fuses or opening the instrument.**
- Replace blown fuse with the same type.**

### 8.3 Service

For repairs under or out of warranty time please contact your distributor for further information.

Unauthorized person is not allowed to open the SigmaGT instrument. There are no user replaceable parts inside the instrument.

### 8.4 Cleaning

Use a soft, slightly moistened cloth with soap water or alcohol to clean the surface of SigmaGT instrument. Leave the instrument to dry totally before using it.

#### Notes:

- Do not use liquids based on petrol or hydrocarbons!
- Do not spill cleaning liquid over the instrument!

## 9 Instrument set and accessories

### Standard set of the instrument MI 3310 SigmaGT

- › Instrument MI 3310 SigmaGT
- › Small soft carrying bag
- › Mains cable 16 A
- › Test lead (black)
- › Test tip (black)
- › Alligator clip (black)
- › IEC test cable, 2 m
- › PC software PATLink PRO with RS232 and USB cables
- › Instruction manual
- › Short instruction manual
- › Declaration of conformity
- › Production verification data
- › 6 Ni-MH rechargeable accus, size C

### Standard set of the instrument MI 3310 25A SigmaGT

- › Instrument MI 3310 25A SigmaGT (with Bluetooth)
- › Small soft carrying bag
- › Mains cable 16 A
- › 3 test leads (brown, green, black)
- › 3 test tips (brown, green, black)
- › 3 alligator clips (brown, green, black)
- › IEC test cable, 2 m
- › PC software PATLink PRO with RS232 and USB cables
- › Instruction manual
- › Short instruction manual
- › Declaration of conformity
- › Production verification data
- › 6 Ni-MH rechargeable accus, size C

### Optional accessories

See the attached sheet for a list of optional accessories that are available on request from your distributor.

## Appendix A – Preprogrammed autotests

### Pre-programmed autotest sequences

No.	Name	Description
1	<b>CI_1_Iso</b>	Testing according to VDE 0701-0702. Class I device. Insulation resistance and substitute leakage current measurements are selected.
2	<b>CI1_Iso_BLT</b>	Testing according to VDE 0701-0702. Class I device with isolated accessible conductive parts. Insulation resistance and substitute leakage current measurements are selected.
3	<b>CI_1_Ia</b>	Testing according to VDE 0701-0702. Class I device. Differential leakage current measurement is selected.
4	<b>CI_1_Ia_BLT</b>	Testing according to VDE 0701-0702. Class I device with isolated accessible conductive parts. Differential leakage current and touch leakage current measurements are selected.
5	<b>CI_2_Iso</b>	Testing according to VDE 0701-0702. Class II device with isolated accessible conductive parts. Insulation resistance and substitute leakage current measurements are selected.
6	<b>CI_2_lbs</b>	Testing according to VDE 0701-0702. Class II device. Touch leakage current measurement is selected.
7	<b>CI_1_Isola</b>	Testing according to VDE 0701-0702. Class I device. Insulation resistance and differential leakage current measurements are selected.
8	<b>CI1_IsolaBLT</b>	Testing according to VDE 0701-0702. Class I device with isolated accessible conductive parts. Insulation resistance, differential leakage current and touch leakage current measurements are selected.
9	<b>CI_2_Isolbs</b>	Testing according to VDE 0701-0702. Class II device with isolated accessible conductive parts. Insulation resistance and touch leakage current measurements are selected.
10	<b>CI_2</b>	Testing according to VDE 0701-0702. Class II device without any isolated accessible conductive parts.
11	<b>CI_3_Iso</b>	Testing according to VDE 0701-0702. Class II device with isolated accessible conductive parts.
12	<b>CI_3</b>	Testing according to VDE 0701-0702. Class II device without any isolated accessible conductive parts.

Pre-programmed autotest sequences table

Autotest shortcut code		01	02	03	04
		CI_1_Iso	CI1_Iso_BLT	CI_1_la	CI_1_la_BLT
<b>Visual test</b>		<input checked="" type="checkbox"/>	<input checked="" type="checkbox"/>	<input checked="" type="checkbox"/>	<input checked="" type="checkbox"/>
<b>Earth bond</b>	Output	200 mA	200 mA	200 mA	200 mA
	Limit	0.30 $\Omega$	0.30 $\Omega$	0.30 $\Omega$	0.30 $\Omega$
	Time	5 s	5 s	5 s	5 s
<b>Insulation</b>	Output	500 V	500 V	<input checked="" type="checkbox"/>	<input checked="" type="checkbox"/>
	Limit	1.00 M $\Omega$	1.00 M $\Omega$	<input checked="" type="checkbox"/>	<input checked="" type="checkbox"/>
	Time	5 s	5 s	<input checked="" type="checkbox"/>	<input checked="" type="checkbox"/>
<b>Insulation (probe)</b>	Output	<input checked="" type="checkbox"/>	500 V	<input checked="" type="checkbox"/>	<input checked="" type="checkbox"/>
	Limit	<input checked="" type="checkbox"/>	2.00 M $\Omega$	<input checked="" type="checkbox"/>	<input checked="" type="checkbox"/>
	Time	<input checked="" type="checkbox"/>	5 s	<input checked="" type="checkbox"/>	<input checked="" type="checkbox"/>
<b>Sub leakage</b>	Output	40 V	40 V	<input checked="" type="checkbox"/>	<input checked="" type="checkbox"/>
	Limit	3.50 mA	3.50 mA	<input checked="" type="checkbox"/>	<input checked="" type="checkbox"/>
	Time	5 s	5 s	<input checked="" type="checkbox"/>	<input checked="" type="checkbox"/>
<b>Sub leakage (probe)</b>	Output	<input checked="" type="checkbox"/>	40 V	<input checked="" type="checkbox"/>	<input checked="" type="checkbox"/>
	Limit	<input checked="" type="checkbox"/>	0.50 mA	<input checked="" type="checkbox"/>	<input checked="" type="checkbox"/>
	Time	<input checked="" type="checkbox"/>	5 s	<input checked="" type="checkbox"/>	<input checked="" type="checkbox"/>
<b>Differential leakage</b>	Output	<input checked="" type="checkbox"/>	<input checked="" type="checkbox"/>	230 V	230 V
	Limit	<input checked="" type="checkbox"/>	<input checked="" type="checkbox"/>	3.50 mA	3.50 mA
	Time	<input checked="" type="checkbox"/>	<input checked="" type="checkbox"/>	180 s	180 s
<b>Touch leakage</b>	Output	<input checked="" type="checkbox"/>	<input checked="" type="checkbox"/>	<input checked="" type="checkbox"/>	230 V
	Limit	<input checked="" type="checkbox"/>	<input checked="" type="checkbox"/>	<input checked="" type="checkbox"/>	0.50 mA
	Time	<input checked="" type="checkbox"/>	<input checked="" type="checkbox"/>	<input checked="" type="checkbox"/>	180 s
<b>Power</b>	Output	230 V	230 V	230 V	230 V
	Limit	<input checked="" type="checkbox"/>	<input checked="" type="checkbox"/>	<input checked="" type="checkbox"/>	<input checked="" type="checkbox"/>
	Time	180 s	180 s	180 s	180 s
<b>TRMS clamp current</b>	Output	<input checked="" type="checkbox"/>	<input checked="" type="checkbox"/>	<input checked="" type="checkbox"/>	<input checked="" type="checkbox"/>
	Limit	<input checked="" type="checkbox"/>	<input checked="" type="checkbox"/>	<input checked="" type="checkbox"/>	<input checked="" type="checkbox"/>
	Time	<input checked="" type="checkbox"/>	<input checked="" type="checkbox"/>	<input checked="" type="checkbox"/>	<input checked="" type="checkbox"/>
<b>Polarity test</b>		<input checked="" type="checkbox"/>	<input checked="" type="checkbox"/>	<input checked="" type="checkbox"/>	<input checked="" type="checkbox"/>



Pre-programmed autotest sequences table (cont'd)

Autotest shortcut code		05	06	07	08
		CI_2_Iso	CI_2_lbs	CI_1_Isola	CI1_IsolaBLT
<b>Visual test</b>		<input checked="" type="checkbox"/>	<input checked="" type="checkbox"/>	<input checked="" type="checkbox"/>	<input checked="" type="checkbox"/>
<b>Earth bond</b>	Output	<input checked="" type="checkbox"/>	<input checked="" type="checkbox"/>	200 mA	200 mA
	Limit	<input checked="" type="checkbox"/>	<input checked="" type="checkbox"/>	0.30 $\Omega$	0.30 $\Omega$
	Time	<input checked="" type="checkbox"/>	<input checked="" type="checkbox"/>	5 s	5 s
<b>Insulation</b>	Output	<input checked="" type="checkbox"/>	<input checked="" type="checkbox"/>	500 V	500 V
	Limit	<input checked="" type="checkbox"/>	<input checked="" type="checkbox"/>	1.00 M $\Omega$	1.00 M $\Omega$
	Time	<input checked="" type="checkbox"/>	<input checked="" type="checkbox"/>	5 s	5 s
<b>Insulation (probe)</b>	Output	500 V	<input checked="" type="checkbox"/>	<input checked="" type="checkbox"/>	500 V
	Limit	2.00 M $\Omega$	<input checked="" type="checkbox"/>	<input checked="" type="checkbox"/>	2.00 M $\Omega$
	Time	5 s	<input checked="" type="checkbox"/>	<input checked="" type="checkbox"/>	5 s
<b>Sub leakage</b>	Output	<input checked="" type="checkbox"/>	<input checked="" type="checkbox"/>	<input checked="" type="checkbox"/>	<input checked="" type="checkbox"/>
	Limit	<input checked="" type="checkbox"/>	<input checked="" type="checkbox"/>	<input checked="" type="checkbox"/>	<input checked="" type="checkbox"/>
	Time	<input checked="" type="checkbox"/>	<input checked="" type="checkbox"/>	<input checked="" type="checkbox"/>	<input checked="" type="checkbox"/>
<b>Sub leakage (probe)</b>	Output	40 V	<input checked="" type="checkbox"/>	<input checked="" type="checkbox"/>	<input checked="" type="checkbox"/>
	Limit	0.50 mA	<input checked="" type="checkbox"/>	<input checked="" type="checkbox"/>	<input checked="" type="checkbox"/>
	Time	5 s	<input checked="" type="checkbox"/>	<input checked="" type="checkbox"/>	<input checked="" type="checkbox"/>
<b>Differential leakage</b>	Output	<input checked="" type="checkbox"/>	<input checked="" type="checkbox"/>	230 V	230 V
	Limit	<input checked="" type="checkbox"/>	<input checked="" type="checkbox"/>	3.50 mA	3.50 mA
	Time	<input checked="" type="checkbox"/>	<input checked="" type="checkbox"/>	180 s	180 s
<b>Touch leakage</b>	Output	<input checked="" type="checkbox"/>	230 V	<input checked="" type="checkbox"/>	230 V
	Limit	<input checked="" type="checkbox"/>	0.50 mA	<input checked="" type="checkbox"/>	0.50 mA
	Time	<input checked="" type="checkbox"/>	180 s	<input checked="" type="checkbox"/>	180 s
<b>Power</b>	Output	230 V	230 V	230 V	230 V
	Limit	<input checked="" type="checkbox"/>	<input checked="" type="checkbox"/>	<input checked="" type="checkbox"/>	<input checked="" type="checkbox"/>
	Time	180 s	180 s	180 s	180 s
<b>TRMS clamp current</b>	Output	<input checked="" type="checkbox"/>	<input checked="" type="checkbox"/>	<input checked="" type="checkbox"/>	<input checked="" type="checkbox"/>
	Limit	<input checked="" type="checkbox"/>	<input checked="" type="checkbox"/>	<input checked="" type="checkbox"/>	<input checked="" type="checkbox"/>
	Time	<input checked="" type="checkbox"/>	<input checked="" type="checkbox"/>	<input checked="" type="checkbox"/>	<input checked="" type="checkbox"/>
<b>Polarity test</b>		<input checked="" type="checkbox"/>	<input checked="" type="checkbox"/>	<input checked="" type="checkbox"/>	<input checked="" type="checkbox"/>



Pre-programmed autotest sequences table (cont'd)

Autotest shortcut code		09	10	11	12
		CI 2 Isolbs	CI 2	CI 3 Iso	CI 3
<b>Visual test</b>		<input checked="" type="checkbox"/>	<input checked="" type="checkbox"/>	<input checked="" type="checkbox"/>	<input checked="" type="checkbox"/>
<b>Earth bond</b>	Output	<input checked="" type="checkbox"/>	<input checked="" type="checkbox"/>	<input checked="" type="checkbox"/>	<input checked="" type="checkbox"/>
	Limit	<input checked="" type="checkbox"/>	<input checked="" type="checkbox"/>	<input checked="" type="checkbox"/>	<input checked="" type="checkbox"/>
	Time	<input checked="" type="checkbox"/>	<input checked="" type="checkbox"/>	<input checked="" type="checkbox"/>	<input checked="" type="checkbox"/>
<b>Insulation</b>	Output	<input checked="" type="checkbox"/>	<input checked="" type="checkbox"/>	<input checked="" type="checkbox"/>	<input checked="" type="checkbox"/>
	Limit	<input checked="" type="checkbox"/>	<input checked="" type="checkbox"/>	<input checked="" type="checkbox"/>	<input checked="" type="checkbox"/>
	Time	<input checked="" type="checkbox"/>	<input checked="" type="checkbox"/>	<input checked="" type="checkbox"/>	<input checked="" type="checkbox"/>
<b>Insulation (probe)</b>	Output	500 V	<input checked="" type="checkbox"/>	500 V	<input checked="" type="checkbox"/>
	Limit	2.00 MΩ	<input checked="" type="checkbox"/>	0.250 MΩ	<input checked="" type="checkbox"/>
	Time	5 s	<input checked="" type="checkbox"/>	5 s	<input checked="" type="checkbox"/>
<b>Sub leakage</b>	Output	<input checked="" type="checkbox"/>	<input checked="" type="checkbox"/>	<input checked="" type="checkbox"/>	<input checked="" type="checkbox"/>
	Limit	<input checked="" type="checkbox"/>	<input checked="" type="checkbox"/>	<input checked="" type="checkbox"/>	<input checked="" type="checkbox"/>
	Time	<input checked="" type="checkbox"/>	<input checked="" type="checkbox"/>	<input checked="" type="checkbox"/>	<input checked="" type="checkbox"/>
<b>Sub leakage (probe)</b>	Output	<input checked="" type="checkbox"/>	<input checked="" type="checkbox"/>	<input checked="" type="checkbox"/>	<input checked="" type="checkbox"/>
	Limit	<input checked="" type="checkbox"/>	<input checked="" type="checkbox"/>	<input checked="" type="checkbox"/>	<input checked="" type="checkbox"/>
	Time	<input checked="" type="checkbox"/>	<input checked="" type="checkbox"/>	<input checked="" type="checkbox"/>	<input checked="" type="checkbox"/>
<b>Differential leakage</b>	Output	<input checked="" type="checkbox"/>	<input checked="" type="checkbox"/>	<input checked="" type="checkbox"/>	<input checked="" type="checkbox"/>
	Limit	<input checked="" type="checkbox"/>	<input checked="" type="checkbox"/>	<input checked="" type="checkbox"/>	<input checked="" type="checkbox"/>
	Time	<input checked="" type="checkbox"/>	<input checked="" type="checkbox"/>	<input checked="" type="checkbox"/>	<input checked="" type="checkbox"/>
<b>Touch leakage</b>	Output	230 V	<input checked="" type="checkbox"/>	<input checked="" type="checkbox"/>	<input checked="" type="checkbox"/>
	Limit	0.50 mA	<input checked="" type="checkbox"/>	<input checked="" type="checkbox"/>	<input checked="" type="checkbox"/>
	Time	180 s	<input checked="" type="checkbox"/>	<input checked="" type="checkbox"/>	<input checked="" type="checkbox"/>
<b>Power</b>	Output	230 V	230 V	---	---
	Limit	<input checked="" type="checkbox"/>	<input checked="" type="checkbox"/>	<input checked="" type="checkbox"/>	<input checked="" type="checkbox"/>
	Time	180 s	180 s	180 s	180 s
<b>TRMS clamp current</b>	Output	<input checked="" type="checkbox"/>	<input checked="" type="checkbox"/>	<input checked="" type="checkbox"/>	<input checked="" type="checkbox"/>
	Limit	<input checked="" type="checkbox"/>	<input checked="" type="checkbox"/>	<input checked="" type="checkbox"/>	<input checked="" type="checkbox"/>
	Time	<input checked="" type="checkbox"/>	<input checked="" type="checkbox"/>	<input checked="" type="checkbox"/>	<input checked="" type="checkbox"/>
<b>Polarity test</b>		<input checked="" type="checkbox"/>	<input checked="" type="checkbox"/>	<input checked="" type="checkbox"/>	<input checked="" type="checkbox"/>

## METREL GmbH VDE tester test type card

Code	Autotest sequence name and descriptions		Limits	Barcode
01	<b>KI_1_Iso</b>	Testing according to VDE. Class 1 device. Insulation resistance and substitute leakage current measurements are applicable.	Earth bond: 0.30 $\Omega$ Insulation: 1.00 M $\Omega$ Sub leakage: 3.50mA	 A0 1
02	<b>KI1_Iso_BLT</b>	Testing according to VDE. Class 1 device with isolated accessible inductive parts. Insulation resistance and substitute leakage current measurements are applicable.	Earth bond: 0.30 $\Omega$ Insulation: 1.00 M $\Omega$ Insulation - S: 2.00 M $\Omega$ Sub leakage: 3.50 mA Sub leakage - S: 0.50 mA	 A0 2
03	<b>KI_1_Ia</b>	Testing according to VDE. Class 1 device. Prüfung für Differenzstrom wird eingestellt.	Earth bond: 0.30 $\Omega$ Leakage: 3.50 mA	 A0 3
04	<b>KI_1_Ia_BLT</b>	Testing according to VDE. Class 1 device with isolated accessible conductive parts. Prüfungen für Differenz- und Berührungsstrom werden eingestellt.	Earth bond: 0.30 $\Omega$ Leakage: 3.50 mA Touch leakage: 0.50 mA	 A0 4
05	<b>KI_2_Iso</b>	Testing according to VDE. Class 2 device with isolated accessible conductive parts. Insulation resistance and substitute leakage current measurements are applicable.	Insulation - S: 2.00 M $\Omega$ Sub leakage - S: 0.50 mA	 A0 5
06	<b>KI_2_Ibs</b>	Testing according to VDE. Class 2 device. Prüfung für Berührungsstrom wird eingestellt.	Touch leakage: 0.50 mA	 A0 6
07	<b>KI_1_Isola</b>	Testing according to VDE. Class 1 device. Prüfungen für Isolation und Differenzstrom werden eingestellt.	Earth bond: 0.30 $\Omega$ Insulation: 1.00 M $\Omega$ Leakage: 3.50 mA	 A0 7
08	<b>KI1_IsolaBLT</b>	Testing according to VDE. Class 1 device with isolated accessible conductive parts. Prüfungen für Isolation, Differenz- und Berührungsstrom werden eingestellt.	Earth bond: 0.30 $\Omega$ Insulation: 1.00 M $\Omega$ Insulation - S: 2.00 M $\Omega$ Leakage: 3.50 mA Touch leakage: 0.50 mA	 A0 8
09	<b>KI_2_Isolbs</b>	Testing according to VDE. Class 2 device with isolated accessible conductive parts. Prüfungen für Isolation und Berührungsstrom werden eingestellt.	Insulation - S: 2.00 M $\Omega$ Touch leakage: 0.50 mA	 A0 9

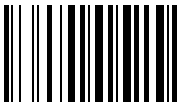
**METREL GmbH VDE tester test type card (cont'd)**

10	<b>KI_2</b>	Testing according to VDE. Class 2 device without any isolated accessible conductive parts.		 A1 0
11	<b>KI_3_Iso</b>	Testing according to VDE. Class 3 device with isolated accessible conductive parts.	Insulation - S: 0.25 MΩ	 A1 1
12	<b>KI_3</b>	Testing according to VDE. Class 3 device without any isolated accessible conductive parts.		 A1 2

**Note:**

- When polarity test is enabled in autotest sequence then earth bond resistance is performed between IEC test connector (PE terminal) and test socket (PE terminal). If polarity test is disabled in autotest sequence, earth bond test is performed between EB/S test probe and test socket (PE terminal).









Pre-programmed autotest sequences table – welding machines

Autotest shortcut code - Welding machines		50	51	52	53	54
		KI1_Iso_RisUmg	KI1_Iso_NorUmg	KI1_Iso_Schutz	KI1_≤32A_Risiko	KI1_≤32A_Normal
<b>Visual test</b>		<input checked="" type="checkbox"/>	<input checked="" type="checkbox"/>	<input checked="" type="checkbox"/>	<input checked="" type="checkbox"/>	<input checked="" type="checkbox"/>
<b>Rpe</b>	Output	200 mA	200 mA	200 mA	200 mA	200 mA
	Limit	0.30 Ω	0.30 Ω	0.30 Ω	0.30 Ω	0.30 Ω
	Time	3 s	3 s	3 s	3 s	3 s
<b>Insulation LN - PE</b>	Output	500 V	500 V	500 V	<input checked="" type="checkbox"/>	<input checked="" type="checkbox"/>
	Limit	2.50 MΩ	2.50 MΩ	2.50 MΩ	<input checked="" type="checkbox"/>	<input checked="" type="checkbox"/>
	Time	3 s	3 s	3 s	<input checked="" type="checkbox"/>	<input checked="" type="checkbox"/>
<b>Insulation W - PE</b>	Output	500 V	500 V	500 V	<input checked="" type="checkbox"/>	<input checked="" type="checkbox"/>
	Limit	2.50 MΩ	2.50 MΩ	2.50 MΩ	<input checked="" type="checkbox"/>	<input checked="" type="checkbox"/>
	Time	3 s	3 s	3 s	<input checked="" type="checkbox"/>	<input checked="" type="checkbox"/>
<b>Insulation LN - W</b>	Output	500 V	500 V	500 V	<input checked="" type="checkbox"/>	<input checked="" type="checkbox"/>
	Limit	5.00 MΩ	5.00 MΩ	5.00 MΩ	<input checked="" type="checkbox"/>	<input checked="" type="checkbox"/>
	Time	3 s	3 s	3 s	<input checked="" type="checkbox"/>	<input checked="" type="checkbox"/>
<b>Insulation LN - probe</b>	Output	<input checked="" type="checkbox"/>	<input checked="" type="checkbox"/>	<input checked="" type="checkbox"/>	<input checked="" type="checkbox"/>	<input checked="" type="checkbox"/>
	Limit	<input checked="" type="checkbox"/>	<input checked="" type="checkbox"/>	<input checked="" type="checkbox"/>	<input checked="" type="checkbox"/>	<input checked="" type="checkbox"/>
	Time	<input checked="" type="checkbox"/>	<input checked="" type="checkbox"/>	<input checked="" type="checkbox"/>	<input checked="" type="checkbox"/>	<input checked="" type="checkbox"/>
<b>Welding leakage</b>	Output	<input checked="" type="checkbox"/>	<input checked="" type="checkbox"/>	<input checked="" type="checkbox"/>	230 V	230 V
	Limit	<input checked="" type="checkbox"/>	<input checked="" type="checkbox"/>	<input checked="" type="checkbox"/>	10.00 mA	10.00 mA
	Time	<input checked="" type="checkbox"/>	<input checked="" type="checkbox"/>	<input checked="" type="checkbox"/>	3 s	3 s
<b>Differential leakage</b>	Output	<input checked="" type="checkbox"/>	<input checked="" type="checkbox"/>	<input checked="" type="checkbox"/>	230 V	230 V
	Limit	<input checked="" type="checkbox"/>	<input checked="" type="checkbox"/>	<input checked="" type="checkbox"/>	5.00 mA	5.00 mA
	Time	<input checked="" type="checkbox"/>	<input checked="" type="checkbox"/>	<input checked="" type="checkbox"/>	3 s	3 s
<b>Touch leakage</b>	Output	<input checked="" type="checkbox"/>	<input checked="" type="checkbox"/>	<input checked="" type="checkbox"/>	<input checked="" type="checkbox"/>	<input checked="" type="checkbox"/>
	Limit	<input checked="" type="checkbox"/>	<input checked="" type="checkbox"/>	<input checked="" type="checkbox"/>	<input checked="" type="checkbox"/>	<input checked="" type="checkbox"/>
	Time	<input checked="" type="checkbox"/>	<input checked="" type="checkbox"/>	<input checked="" type="checkbox"/>	<input checked="" type="checkbox"/>	<input checked="" type="checkbox"/>
<b>No load voltage</b>	Limit d.c.	113 Vpeak	113 Vpeak	141 Vpeak	113 Vpeak	113 Vpeak
	Limit a.c.	68 Vpeak 48 Vrms	113 Vpeak 80 Vrms	141 Vpeak 100 Vrms	68 Vpeak 48 Vrms	113 Vpeak 80 Vrms
<b>TRMS clamp current</b>	Output	<input checked="" type="checkbox"/>	<input checked="" type="checkbox"/>	<input checked="" type="checkbox"/>	<input checked="" type="checkbox"/>	<input checked="" type="checkbox"/>
	Limit	<input checked="" type="checkbox"/>	<input checked="" type="checkbox"/>	<input checked="" type="checkbox"/>	<input checked="" type="checkbox"/>	<input checked="" type="checkbox"/>
	Time	<input checked="" type="checkbox"/>	<input checked="" type="checkbox"/>	<input checked="" type="checkbox"/>	<input checked="" type="checkbox"/>	<input checked="" type="checkbox"/>
<b>Functional test</b>		<input checked="" type="checkbox"/>	<input checked="" type="checkbox"/>	<input checked="" type="checkbox"/>	<input checked="" type="checkbox"/>	<input checked="" type="checkbox"/>

Pre-programmed autotest sequences table – welding machines (cont'd)

Autotest shortcut code Welding machines		55	56	57	58
		KI1_≤32A_Schutz	KI1_>32A_Risiko	KI1_>32A_Normal	KI1_>32A_Schutz
<b>Visual test</b>		<input checked="" type="checkbox"/>	<input checked="" type="checkbox"/>	<input checked="" type="checkbox"/>	<input checked="" type="checkbox"/>
<b>Rpe</b>	Output	200 mA	200 mA	200 mA	200 mA
	Limit	0.30 Ω	0.30 Ω	0.30 Ω	0.30 Ω
	Time	3 s	3 s	3 s	3 s
<b>Insulation LN - PE</b>	Output	<input checked="" type="checkbox"/>	<input checked="" type="checkbox"/>	<input checked="" type="checkbox"/>	<input checked="" type="checkbox"/>
	Limit	<input checked="" type="checkbox"/>	<input checked="" type="checkbox"/>	<input checked="" type="checkbox"/>	<input checked="" type="checkbox"/>
	Time	<input checked="" type="checkbox"/>	<input checked="" type="checkbox"/>	<input checked="" type="checkbox"/>	<input checked="" type="checkbox"/>
<b>Insulation W - PE</b>	Output	<input checked="" type="checkbox"/>	<input checked="" type="checkbox"/>	<input checked="" type="checkbox"/>	<input checked="" type="checkbox"/>
	Limit	<input checked="" type="checkbox"/>	<input checked="" type="checkbox"/>	<input checked="" type="checkbox"/>	<input checked="" type="checkbox"/>
	Time	<input checked="" type="checkbox"/>	<input checked="" type="checkbox"/>	<input checked="" type="checkbox"/>	<input checked="" type="checkbox"/>
<b>Insulation LN - W</b>	Output	<input checked="" type="checkbox"/>	<input checked="" type="checkbox"/>	<input checked="" type="checkbox"/>	<input checked="" type="checkbox"/>
	Limit	<input checked="" type="checkbox"/>	<input checked="" type="checkbox"/>	<input checked="" type="checkbox"/>	<input checked="" type="checkbox"/>
	Time	<input checked="" type="checkbox"/>	<input checked="" type="checkbox"/>	<input checked="" type="checkbox"/>	<input checked="" type="checkbox"/>
<b>Insulation LN - probe</b>	Output	<input checked="" type="checkbox"/>	<input checked="" type="checkbox"/>	<input checked="" type="checkbox"/>	<input checked="" type="checkbox"/>
	Limit	<input checked="" type="checkbox"/>	<input checked="" type="checkbox"/>	<input checked="" type="checkbox"/>	<input checked="" type="checkbox"/>
	Time	<input checked="" type="checkbox"/>	<input checked="" type="checkbox"/>	<input checked="" type="checkbox"/>	<input checked="" type="checkbox"/>
<b>Welding leakage</b>	Output	230 V	230 V	230 V	230 V
	Limit	10.00 mA	10.00 mA	10.00 mA	10.00 mA
	Time	3 s	3 s	3 s	3 s
<b>Differential leakage</b>	Output	230 V	230 V	230 V	230 V
	Limit	5.00 mA	10.00 mA	10.00 mA	10.00 mA
	Time	3 s	3 s	3 s	3 s
<b>Touch leakage</b>	Output	<input checked="" type="checkbox"/>	<input checked="" type="checkbox"/>	<input checked="" type="checkbox"/>	<input checked="" type="checkbox"/>
	Limit	<input checked="" type="checkbox"/>	<input checked="" type="checkbox"/>	<input checked="" type="checkbox"/>	<input checked="" type="checkbox"/>
	Time	<input checked="" type="checkbox"/>	<input checked="" type="checkbox"/>	<input checked="" type="checkbox"/>	<input checked="" type="checkbox"/>
<b>No load voltage</b>	Limit d.c.	141 Vpeak	113 Vpeak	113 Vpeak	141 Vpeak
	Limit a.c.	141 Vpeak 100 Vrms	68 Vpeak 48 Vrms	113 Vpeak 80 Vrms	141 Vpeak 100 Vrms
<b>TRMS clamp current</b>	Output	<input checked="" type="checkbox"/>	<input checked="" type="checkbox"/>	<input checked="" type="checkbox"/>	<input checked="" type="checkbox"/>
	Limit	<input checked="" type="checkbox"/>	<input checked="" type="checkbox"/>	<input checked="" type="checkbox"/>	<input checked="" type="checkbox"/>
	Time	<input checked="" type="checkbox"/>	<input checked="" type="checkbox"/>	<input checked="" type="checkbox"/>	<input checked="" type="checkbox"/>
<b>Functional test</b>		<input checked="" type="checkbox"/>	<input checked="" type="checkbox"/>	<input checked="" type="checkbox"/>	<input checked="" type="checkbox"/>

## Welding machines – Test type card

Code	Autotest sequence name and descriptions		Limits	Barcode
50	KI1_Iso_RisUmg	Class 1 device. Insulation resistance test is applicable. Environment with increased risk of electric shock.	Rpe: 0.30 $\Omega$ Ins LN-PE: 2.5 M $\Omega$ Ins W-PE: 2.5 M $\Omega$ Ins LN-W: 5.0 M $\Omega$ U <sub>0</sub> : d.c. 113 V <sub>p</sub> / a.c. 68 V <sub>p</sub> and 48 V <sub>rms</sub>	 A50
51	KI1_Iso_NorUmg	Class 1 device. Insulation resistance test is applicable. Environment without increased risk of electric shock.	Rpe: 0.30 $\Omega$ Ins LN-PE: 2.5 M $\Omega$ Ins W-PE: 2.5 M $\Omega$ Ins LN-W: 5.0 M $\Omega$ U <sub>0</sub> : d.c. 113 V <sub>p</sub> / a.c. 113 V <sub>p</sub> and 80 V <sub>rms</sub>	 A51
52	KI1_Iso_Schutz	Class 1 device. Insulation resistance test is applicable. Mechanically held torches with increased protection for the operator.	Rpe: 0.30 $\Omega$ Ins LN-PE: 2.5 M $\Omega$ Ins W-PE: 2.5 M $\Omega$ Ins LN-W: 5.0 M $\Omega$ U <sub>0</sub> : d.c. 141 V <sub>p</sub> / a.c. 141V <sub>p</sub> and 100 V <sub>rms</sub>	 A52
53	KI1_≤32A_Risiko	Class 1 device. Primary and welding circuit leakage current tests are applicable. Plug connected equipment rated ≤ 32 A. Environment with increased risk of electric shock.	Rpe: 0.30 $\Omega$ I leak-W: 10 mA I diff: 5 mA U <sub>0</sub> : d.c. 113 V <sub>p</sub> / a.c. 68 V <sub>p</sub> and 48 V <sub>rms</sub>	 A53
54	KI1_≤32A_Normal	Class 1 device. Primary and welding circuit leakage current tests are applicable. Plug connected equipment rated ≤32 A. Environment without increased risk of electric shock.	Rpe: 0.30 $\Omega$ I leak-W: 10 mA I diff: 5 mA U <sub>0</sub> : d.c. 113 V <sub>p</sub> / a.c. 113 V <sub>p</sub> and 80 V <sub>rms</sub>	 A54
55	KI1_≤32A_Schutz	Class 1 device. Primary and welding circuit leakage current tests are applicable. Plug connected equipment rated ≤ 32 A. Mechanically held torches with increased protection for the operator.	Rpe: 0.30 $\Omega$ I leak-W: 10 mA I diff: 5 mA U <sub>0</sub> : d.c. 141 V <sub>p</sub> / a.c. 141 V <sub>p</sub> and 100 V <sub>rms</sub>	 A55
56	KI1_>32A_Risiko	Class 1 device. Primary and welding circuit leakage current tests are applicable. Plug connected equipment rated > 32 A or fixed installed equipment. Environment with increased risk of electric shock.	Rpe: 0.30 $\Omega$ I leak-W: 10 mA I diff: 10 mA U <sub>0</sub> : d.c. 113 V <sub>p</sub> / a.c. 68 V <sub>p</sub> and 48 V <sub>rms</sub>	 A56
57	KI1_>32A_Normal	Class 1 device. Primary and welding circuit leakage current tests are applicable. Plug connected equipment rated > 32 A or fixed installed equipment. Environment without increased risk of electric shock.	Rpe: 0.30 $\Omega$ I leak-W: 10 mA I diff: 10 mA U <sub>0</sub> : d.c. 113 V <sub>p</sub> / a.c. 113 V <sub>p</sub> and 80 V <sub>rms</sub>	 A57
58	KI1_>32A_Schutz	Class 1 device. Primary and welding circuit leakage current tests are applicable. Plug connected equipment rated > 32 A or fixed installed equipment. Mechanically held torches with increased protection for the operator.	Rpe: 0.30 $\Omega$ I leak-W: 10 mA I diff: 10 mA U <sub>0</sub> : d.c. 141 V <sub>p</sub> / a.c. 141V <sub>p</sub> and 100 V <sub>rms</sub>	 A58

## Appendix B – Barcode and QR code formats

The instrument SigmaGT supports two barcode formats when printing device labels.

### Autotest shortcut code and DUT number

Autotest shortcut codes are represented as a two digit code. These autotest codes can also be represented by the barcode.

Using the barcode reader, the instruments can accept autotest shortcut code from barcode label.



Autotest shortcut code

Also DUT number can be read from barcode label.

### Single / double barcode system

If single barcode system is selected in the instrument, only DUT name is printed out as a barcode on device barcode label.

When double barcode system is selected in the instrument, both autotest shortcut code and DUT name are printed out as a barcode on DUT barcode label.

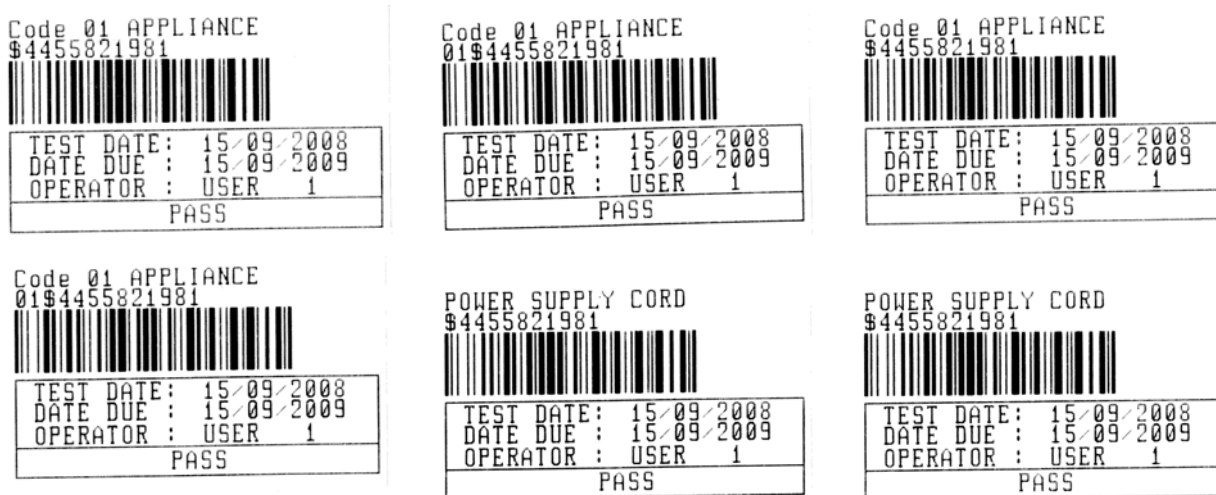

1 tag, barcode system:  
single (top label)  
1 tag, barcode system:  
double (bottom label)

2 tags, barcode system:  
double

2 tags, barcode system:  
single

Examples of DUT labels



01	Autotest shortcut code
\$	Separator
4455821981	DUT number

Refer to chapter 4.2.8.6 *Instrument settings* for barcode system selection.

**Notes:**

- Special character »\$« between autotest shortcut code and DUT name (ID number) is used to distinguish shortcut code from DUT name.
- Only DUT ID is printed out on the 2<sup>nd</sup> DUT label (power supply cord label).

**QR code formats**

The instrument also supports QR code format.

Autotest code, Appliance ID, Appliance name, Re-Test period, Location, and results of tests can be represented by QR code.



*Example of QR code*

## Appendix C – Country notes

This appendix C contains collection of minor modifications related to particular country version. Some of the modifications mean modified characteristics of listed function related to main chapters and others are additional functions. Some minor modifications are also related to different requirements of the same market that are covered by various suppliers.

### C.1 List of country modifications

The following table contains current list of applied modifications.

Country	Related chapters	Modification type	Note
NL	4.2.1, 6.1.1, 6.1.2, F.2	Appended	6.1.2. replaced with F.2.2

### F.2 Modification issues - NL

#### F.2.1 Autotest organizer

Modified screen examples:

Chapter 4.2.1

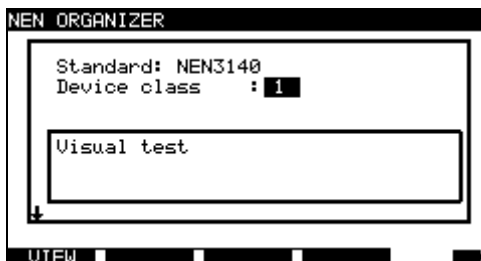

Autotest organizer menu

Chapter 6.1.1

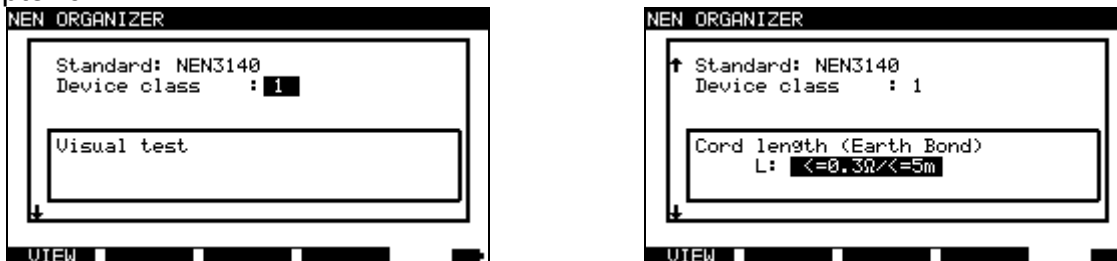

Examples of Autotest organizer screen

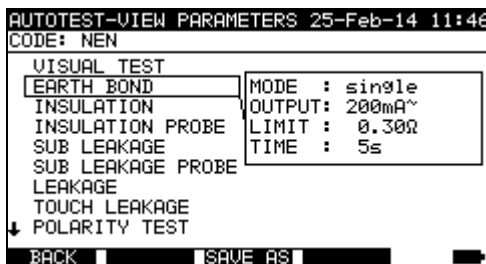

Autotest organizer view menu

### F.2.2 Example of creating a test sequence with autotest organizer

A periodic test of an iron will be performed.

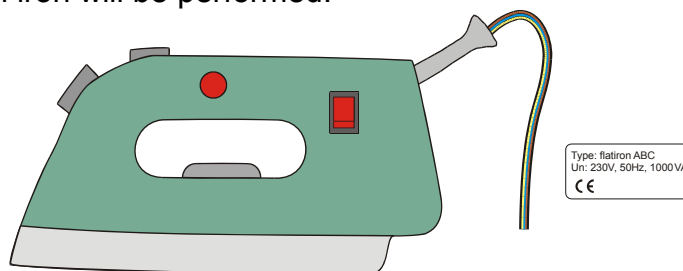

The iron can be classified as followed:

- For a periodic testing, e.g. the NEN 3140 test is relevant.
- The iron can be classified as a Class I DUT with isolated metal part and short supply cord.

Example of test sequence configuration:

	Displayed item	Activity
1	Standard: NEN 3140	Information that a test acc. to NEN 3140 (see note) will be set. <b>Note:</b> <input type="checkbox"/> Option on request.
2	DUT class: <b>I</b>	Selection of DUT safety class: - Select Class I.
3	Visual test	Information that visual test will be included in the VDE / Class I procedure.
4	Accessible conductive parts? <b>YES</b>	Question if there is an isolated conductive part on the DUT: - Confirm with yes.
5	Cord length (Earth bond) L: <b>&lt; 0.3 Ω / &lt;= 5 m</b>	Selection of Earth bond limit value on base of known supply cable length: - Select appropriate length.
6	Insulation test applicable? <b>YES</b>	Question if insulation test is applicable: - Confirm with yes.  Insulation and substitute leakage measurements will be included in the test sequence with this confirmation.
7		Classification of DUT:

	Heating elements L: >0.5 MΩ	- Classify the iron as a standard DUT.
8	Insulation test Accessible cond. Parts L: >2.0 MΩ	Information that insulation resistance measurement of Class 2 parts will be included in the (NEN / Class I / with isolated accessible conductive parts) test procedure.
9	Leakage test method: Leakage	Selection of leakage current test method: - Select substitute leakage measurement.
10	Limit / Device type General device I < 1 mA	Classify the iron as an standard DUT with power <3.5 kW.
11	Touch leakage method: Substitute leakage Limit < 0.5 mA	Information that substitute leakage current measurement class 2 parts will be included in the (NEN / Class I / with isolated accessible conductive parts) test procedure.

The following parameters can be viewed in general for all measurements / tests:

- › Measurement mode,
- › Output test voltage or current (except in visual test and TRMS current measurement),
- › Pass level (except in visual test),
- › Measurement duration (except in visual test).

## F.2.3 Autotest codes

## Pre-programmed autotest sequences table (NL)

Autotest shortcut code		01	02	03	04	05
Description		KL 1 ALG	KL 2 ALG	KL1 HEATERS	KL1 LEKSTROOM	KL3 ALG
<b>Visual test</b>		<input checked="" type="checkbox"/>	<input checked="" type="checkbox"/>	<input checked="" type="checkbox"/>	<input checked="" type="checkbox"/>	<input checked="" type="checkbox"/>
<b>Earth bond</b>	Output	200 mA	<input checked="" type="checkbox"/>	200 mA	200 mA	<input checked="" type="checkbox"/>
	Limit	0.30 $\Omega$	<input checked="" type="checkbox"/>	0.30 $\Omega$	0.30 $\Omega$	<input checked="" type="checkbox"/>
	Time	5 s	<input checked="" type="checkbox"/>	5 s	5 s	<input checked="" type="checkbox"/>
<b>Insulation</b>	Output	500 V	<input checked="" type="checkbox"/>	500 V	<input checked="" type="checkbox"/>	<input checked="" type="checkbox"/>
	Limit	1.00 M $\Omega$	<input checked="" type="checkbox"/>	0.25 M $\Omega$	<input checked="" type="checkbox"/>	<input checked="" type="checkbox"/>
	Time	5 s	<input checked="" type="checkbox"/>	5 s	<input checked="" type="checkbox"/>	<input checked="" type="checkbox"/>
<b>Insulation (probe)</b>	Output	<input checked="" type="checkbox"/>	500 V	<input checked="" type="checkbox"/>	<input checked="" type="checkbox"/>	500 V
	Limit	<input checked="" type="checkbox"/>	2.00 M $\Omega$	<input checked="" type="checkbox"/>	<input checked="" type="checkbox"/>	0.50 M $\Omega$
	Time	<input checked="" type="checkbox"/>	5 s	<input checked="" type="checkbox"/>	<input checked="" type="checkbox"/>	5 s
<b>Sub leakage</b>	Output	<input checked="" type="checkbox"/>	<input checked="" type="checkbox"/>	40 V	<input checked="" type="checkbox"/>	<input checked="" type="checkbox"/>
	Limit	<input checked="" type="checkbox"/>	<input checked="" type="checkbox"/>	7 mA	<input checked="" type="checkbox"/>	<input checked="" type="checkbox"/>
	Time	<input checked="" type="checkbox"/>	<input checked="" type="checkbox"/>	5 s	<input checked="" type="checkbox"/>	<input checked="" type="checkbox"/>
<b>Sub leakage (probe)</b>	Output	<input checked="" type="checkbox"/>	<input checked="" type="checkbox"/>	<input checked="" type="checkbox"/>	<input checked="" type="checkbox"/>	<input checked="" type="checkbox"/>
	Limit	<input checked="" type="checkbox"/>	<input checked="" type="checkbox"/>	<input checked="" type="checkbox"/>	<input checked="" type="checkbox"/>	<input checked="" type="checkbox"/>
	Time	<input checked="" type="checkbox"/>	<input checked="" type="checkbox"/>	<input checked="" type="checkbox"/>	<input checked="" type="checkbox"/>	<input checked="" type="checkbox"/>
<b>Differential leakage</b>	Output	<input checked="" type="checkbox"/>	<input checked="" type="checkbox"/>	<input checked="" type="checkbox"/>	230 V	<input checked="" type="checkbox"/>
	Limit	<input checked="" type="checkbox"/>	<input checked="" type="checkbox"/>	<input checked="" type="checkbox"/>	0.5 mA	<input checked="" type="checkbox"/>
	Time	<input checked="" type="checkbox"/>	<input checked="" type="checkbox"/>	<input checked="" type="checkbox"/>	10 s	<input checked="" type="checkbox"/>
<b>Touch leakage</b>	Output	<input checked="" type="checkbox"/>	<input checked="" type="checkbox"/>	<input checked="" type="checkbox"/>	<input checked="" type="checkbox"/>	<input checked="" type="checkbox"/>
	Limit	<input checked="" type="checkbox"/>	<input checked="" type="checkbox"/>	<input checked="" type="checkbox"/>	<input checked="" type="checkbox"/>	<input checked="" type="checkbox"/>
	Time	<input checked="" type="checkbox"/>	<input checked="" type="checkbox"/>	<input checked="" type="checkbox"/>	<input checked="" type="checkbox"/>	<input checked="" type="checkbox"/>
<b>Power</b>	Output	230 V	230 V	230 V	230 V	<input checked="" type="checkbox"/>
	Limit	<input checked="" type="checkbox"/>	<input checked="" type="checkbox"/>	<input checked="" type="checkbox"/>	<input checked="" type="checkbox"/>	<input checked="" type="checkbox"/>
	Time	10 s	10 s	10 s	10 s	<input checked="" type="checkbox"/>
<b>TRMS clamp current</b>	Output	<input checked="" type="checkbox"/>	<input checked="" type="checkbox"/>	<input checked="" type="checkbox"/>	<input checked="" type="checkbox"/>	<input checked="" type="checkbox"/>
	Limit	<input checked="" type="checkbox"/>	<input checked="" type="checkbox"/>	<input checked="" type="checkbox"/>	<input checked="" type="checkbox"/>	<input checked="" type="checkbox"/>
	Time	<input checked="" type="checkbox"/>	<input checked="" type="checkbox"/>	<input checked="" type="checkbox"/>	<input checked="" type="checkbox"/>	<input checked="" type="checkbox"/>
<b>Polarity test</b>		<input checked="" type="checkbox"/>	<input checked="" type="checkbox"/>	<input checked="" type="checkbox"/>	<input checked="" type="checkbox"/>	<input checked="" type="checkbox"/>
<b>RCD test</b>	Mode	<input checked="" type="checkbox"/>	<input checked="" type="checkbox"/>	<input checked="" type="checkbox"/>	<input checked="" type="checkbox"/>	<input checked="" type="checkbox"/>
	Type	<input checked="" type="checkbox"/>	<input checked="" type="checkbox"/>	<input checked="" type="checkbox"/>	<input checked="" type="checkbox"/>	<input checked="" type="checkbox"/>
	Id RCD	<input checked="" type="checkbox"/>	<input checked="" type="checkbox"/>	<input checked="" type="checkbox"/>	<input checked="" type="checkbox"/>	<input checked="" type="checkbox"/>
	Multi	<input checked="" type="checkbox"/>	<input checked="" type="checkbox"/>	<input checked="" type="checkbox"/>	<input checked="" type="checkbox"/>	<input checked="" type="checkbox"/>
	Fase	<input checked="" type="checkbox"/>	<input checked="" type="checkbox"/>	<input checked="" type="checkbox"/>	<input checked="" type="checkbox"/>	<input checked="" type="checkbox"/>
	Test	<input checked="" type="checkbox"/>	<input checked="" type="checkbox"/>	<input checked="" type="checkbox"/>	<input checked="" type="checkbox"/>	<input checked="" type="checkbox"/>

## Pre-programmed autotest sequences table (cont'd)

Autotest shortcut code		06	07	08	09	10
Description		KL1+2	HASPEL 5 M 2.5 MM	HASPEL 15 M 2.5 MM	HASPEL 25 M 2.5 MM	HASPEL 50 M 2.5 MM
Visual test		<input checked="" type="checkbox"/>	<input checked="" type="checkbox"/>	<input checked="" type="checkbox"/>	<input checked="" type="checkbox"/>	<input checked="" type="checkbox"/>
Earth bond	Output	200 mA	200 mA	200 mA	200 mA	200 mA
	Limit	1.00 $\Omega$	0.30 $\Omega$	0.50 $\Omega$	0.70 $\Omega$	1.00 $\Omega$
	Time	5 s	5 s	5 s	5 s	5 s
Insulation	Output	500 V	500 V	500 V	500 V	500 V
	Limit	1.00 M $\Omega$	1.00 M $\Omega$	1.00 M $\Omega$	1.00 M $\Omega$	1.00 M $\Omega$
	Time	5 s	5 s	5 s	5 s	5 s
Insulation (probe)	Output	500 V	<input checked="" type="checkbox"/>	<input checked="" type="checkbox"/>	<input checked="" type="checkbox"/>	<input checked="" type="checkbox"/>
	Limit	2.00 M $\Omega$	<input checked="" type="checkbox"/>	<input checked="" type="checkbox"/>	<input checked="" type="checkbox"/>	<input checked="" type="checkbox"/>
	Time	5 s	<input checked="" type="checkbox"/>	<input checked="" type="checkbox"/>	<input checked="" type="checkbox"/>	<input checked="" type="checkbox"/>
Sub leakage	Output	<input checked="" type="checkbox"/>	<input checked="" type="checkbox"/>	<input checked="" type="checkbox"/>	<input checked="" type="checkbox"/>	<input checked="" type="checkbox"/>
	Limit	<input checked="" type="checkbox"/>	<input checked="" type="checkbox"/>	<input checked="" type="checkbox"/>	<input checked="" type="checkbox"/>	<input checked="" type="checkbox"/>
	Time	<input checked="" type="checkbox"/>	<input checked="" type="checkbox"/>	<input checked="" type="checkbox"/>	<input checked="" type="checkbox"/>	<input checked="" type="checkbox"/>
Sub leakage (probe)	Output	<input checked="" type="checkbox"/>	<input checked="" type="checkbox"/>	<input checked="" type="checkbox"/>	<input checked="" type="checkbox"/>	<input checked="" type="checkbox"/>
	Limit	<input checked="" type="checkbox"/>	<input checked="" type="checkbox"/>	<input checked="" type="checkbox"/>	<input checked="" type="checkbox"/>	<input checked="" type="checkbox"/>
	Time	<input checked="" type="checkbox"/>	<input checked="" type="checkbox"/>	<input checked="" type="checkbox"/>	<input checked="" type="checkbox"/>	<input checked="" type="checkbox"/>
Differential leakage	Output	230 V	<input checked="" type="checkbox"/>	<input checked="" type="checkbox"/>	<input checked="" type="checkbox"/>	<input checked="" type="checkbox"/>
	Limit	0.5 mA	<input checked="" type="checkbox"/>	<input checked="" type="checkbox"/>	<input checked="" type="checkbox"/>	<input checked="" type="checkbox"/>
	Time	10 s	<input checked="" type="checkbox"/>	<input checked="" type="checkbox"/>	<input checked="" type="checkbox"/>	<input checked="" type="checkbox"/>
Touch leakage	Output	230 V	<input checked="" type="checkbox"/>	<input checked="" type="checkbox"/>	<input checked="" type="checkbox"/>	<input checked="" type="checkbox"/>
	Limit	0.25 mA	<input checked="" type="checkbox"/>	<input checked="" type="checkbox"/>	<input checked="" type="checkbox"/>	<input checked="" type="checkbox"/>
	Time	10 s	<input checked="" type="checkbox"/>	<input checked="" type="checkbox"/>	<input checked="" type="checkbox"/>	<input checked="" type="checkbox"/>
Power	Output	230 V	<input checked="" type="checkbox"/>	<input checked="" type="checkbox"/>	<input checked="" type="checkbox"/>	<input checked="" type="checkbox"/>
	Limit	<input checked="" type="checkbox"/>	<input checked="" type="checkbox"/>	<input checked="" type="checkbox"/>	<input checked="" type="checkbox"/>	<input checked="" type="checkbox"/>
	Time	10 s	<input checked="" type="checkbox"/>	<input checked="" type="checkbox"/>	<input checked="" type="checkbox"/>	<input checked="" type="checkbox"/>
TRMS clamp current	Output	<input checked="" type="checkbox"/>	<input checked="" type="checkbox"/>	<input checked="" type="checkbox"/>	<input checked="" type="checkbox"/>	<input checked="" type="checkbox"/>
	Limit	<input checked="" type="checkbox"/>	<input checked="" type="checkbox"/>	<input checked="" type="checkbox"/>	<input checked="" type="checkbox"/>	<input checked="" type="checkbox"/>
	Time	<input checked="" type="checkbox"/>	<input checked="" type="checkbox"/>	<input checked="" type="checkbox"/>	<input checked="" type="checkbox"/>	<input checked="" type="checkbox"/>
Polarity test		<input checked="" type="checkbox"/>	<input checked="" type="checkbox"/> normal	<input checked="" type="checkbox"/> normal	<input checked="" type="checkbox"/> normal	<input checked="" type="checkbox"/> normal
RCD test	Mode	<input checked="" type="checkbox"/>	<input checked="" type="checkbox"/>	<input checked="" type="checkbox"/>	<input checked="" type="checkbox"/>	<input checked="" type="checkbox"/>
	Type	<input checked="" type="checkbox"/>	<input checked="" type="checkbox"/>	<input checked="" type="checkbox"/>	<input checked="" type="checkbox"/>	<input checked="" type="checkbox"/>
	Id RCD	<input checked="" type="checkbox"/>	<input checked="" type="checkbox"/>	<input checked="" type="checkbox"/>	<input checked="" type="checkbox"/>	<input checked="" type="checkbox"/>
	Multi	<input checked="" type="checkbox"/>	<input checked="" type="checkbox"/>	<input checked="" type="checkbox"/>	<input checked="" type="checkbox"/>	<input checked="" type="checkbox"/>
	Fase	<input checked="" type="checkbox"/>	<input checked="" type="checkbox"/>	<input checked="" type="checkbox"/>	<input checked="" type="checkbox"/>	<input checked="" type="checkbox"/>
	Test	<input checked="" type="checkbox"/>	<input checked="" type="checkbox"/>	<input checked="" type="checkbox"/>	<input checked="" type="checkbox"/>	<input checked="" type="checkbox"/>

## Pre-programmed autotest sequences table (cont'd)

Autotest shortcut code		11	12	13	14
Description		KL1 30mA PRCD	KL1 3L+N(VL 2E)	KL2 LEKSTROOM	KL1 LEKSTROOMTANG
Visual test		<input checked="" type="checkbox"/>	<input checked="" type="checkbox"/>	<input checked="" type="checkbox"/>	<input checked="" type="checkbox"/>
Earth bond	Output	200 mA	200 mA	<input checked="" type="checkbox"/>	200 mA
	Limit	0.30 Ω	0.30 Ω	<input checked="" type="checkbox"/>	0.30 Ω
	Time	5 s	5 s	<input checked="" type="checkbox"/>	5 s
Insulation	Output	500 V	500 V	<input checked="" type="checkbox"/>	<input checked="" type="checkbox"/>
	Limit	1.00 MΩ	1.00 MΩ	<input checked="" type="checkbox"/>	<input checked="" type="checkbox"/>
	Time	5 s	5 s	<input checked="" type="checkbox"/>	<input checked="" type="checkbox"/>
Insulation (probe)	Output	<input checked="" type="checkbox"/>	<input checked="" type="checkbox"/>	<input checked="" type="checkbox"/>	<input checked="" type="checkbox"/>
	Limit	<input checked="" type="checkbox"/>	<input checked="" type="checkbox"/>	<input checked="" type="checkbox"/>	<input checked="" type="checkbox"/>
	Time	<input checked="" type="checkbox"/>	<input checked="" type="checkbox"/>	<input checked="" type="checkbox"/>	<input checked="" type="checkbox"/>
Sub leakage	Output	<input checked="" type="checkbox"/>	<input checked="" type="checkbox"/>	<input checked="" type="checkbox"/>	<input checked="" type="checkbox"/>
	Limit	<input checked="" type="checkbox"/>	<input checked="" type="checkbox"/>	<input checked="" type="checkbox"/>	<input checked="" type="checkbox"/>
	Time	<input checked="" type="checkbox"/>	<input checked="" type="checkbox"/>	<input checked="" type="checkbox"/>	<input checked="" type="checkbox"/>
Sub leakage (probe)	Output	<input checked="" type="checkbox"/>	<input checked="" type="checkbox"/>	<input checked="" type="checkbox"/>	<input checked="" type="checkbox"/>
	Limit	<input checked="" type="checkbox"/>	<input checked="" type="checkbox"/>	<input checked="" type="checkbox"/>	<input checked="" type="checkbox"/>
	Time	<input checked="" type="checkbox"/>	<input checked="" type="checkbox"/>	<input checked="" type="checkbox"/>	<input checked="" type="checkbox"/>
Differential leakage	Output	<input checked="" type="checkbox"/>	<input checked="" type="checkbox"/>	230 V	<input checked="" type="checkbox"/>
	Limit	<input checked="" type="checkbox"/>	<input checked="" type="checkbox"/>	0.5 mA	<input checked="" type="checkbox"/>
	Time	<input checked="" type="checkbox"/>	<input checked="" type="checkbox"/>	10 s	<input checked="" type="checkbox"/>
Touch leakage	Output	<input checked="" type="checkbox"/>	<input checked="" type="checkbox"/>	<input checked="" type="checkbox"/>	<input checked="" type="checkbox"/>
	Limit	<input checked="" type="checkbox"/>	<input checked="" type="checkbox"/>	<input checked="" type="checkbox"/>	<input checked="" type="checkbox"/>
	Time	<input checked="" type="checkbox"/>	<input checked="" type="checkbox"/>	<input checked="" type="checkbox"/>	<input checked="" type="checkbox"/>
Power	Output	<input checked="" type="checkbox"/>	<input checked="" type="checkbox"/>	230 V	<input checked="" type="checkbox"/>
	Limit	<input checked="" type="checkbox"/>	<input checked="" type="checkbox"/>	<input checked="" type="checkbox"/>	<input checked="" type="checkbox"/>
	Time	<input checked="" type="checkbox"/>	<input checked="" type="checkbox"/>	10 s	<input checked="" type="checkbox"/>
TRMS clamp current	Output	<input checked="" type="checkbox"/>	<input checked="" type="checkbox"/>	<input checked="" type="checkbox"/>	Enkel
	Limit	<input checked="" type="checkbox"/>	<input checked="" type="checkbox"/>	<input checked="" type="checkbox"/>	0.5 mA
	Time	<input checked="" type="checkbox"/>	<input checked="" type="checkbox"/>	<input checked="" type="checkbox"/>	5 s
Polarity test		<input checked="" type="checkbox"/>	<input checked="" type="checkbox"/>	<input checked="" type="checkbox"/>	<input checked="" type="checkbox"/>
RCD test	Mode	Single	<input checked="" type="checkbox"/>	<input checked="" type="checkbox"/>	<input checked="" type="checkbox"/>
	Type	AC	<input checked="" type="checkbox"/>	<input checked="" type="checkbox"/>	<input checked="" type="checkbox"/>
	Id RCD	30 mA	<input checked="" type="checkbox"/>	<input checked="" type="checkbox"/>	<input checked="" type="checkbox"/>
	Multi	1	<input checked="" type="checkbox"/>	<input checked="" type="checkbox"/>	<input checked="" type="checkbox"/>
	Fase	(+)	<input checked="" type="checkbox"/>	<input checked="" type="checkbox"/>	<input checked="" type="checkbox"/>
	Test	PRCD	<input checked="" type="checkbox"/>	<input checked="" type="checkbox"/>	<input checked="" type="checkbox"/>

## Note:

- When polarity test is enabled in autotest sequence then earth bond resistance is performed between IEC test connector (PE terminal) and test socket (PE terminal). If polarity test is disabled in autotest sequence, earth bond test is performed between EB/S test probe and test socket (PE terminal).